

**MANUAL ON  
SAMPLING, ANALYSIS  
AND  
CHARACTERISATION OF  
HAZARDOUS WASTES**



**CENTRAL POLLUTION CONTROL BOARD  
MINISTRY OF ENVIRONMENT & FORESTS**

e-mail : [cpcb@nic.gov.in](mailto:cpcb@nic.gov.in)  
Website : [www.cpcb.ecm.in](http://www.cpcb.ecm.in)

August, 2003

## FOREWORD

The hazardous wastes generated from industrial processes need to be properly treated and disposed to avoid contamination of soil, surface and ground water. For ascertaining the nature and extent of mitigative measures, the hazardous wastes are required to be analysed and characterised.

The Ministry of Environment & Forests, Govt. of India has promulgated the Hazardous Waste (Management & Handling) Rules, 1989 and subsequently, amended the Rules in January 2000. The major amendments to these Rules include classification of wastes based on processes & waste streams (industry sector-wise) and also based on concentration limits and characteristics of the wastes. According to the schedule 4, one of the responsibilities of the Central Pollution Control Board (CPCB) is to recommend procedures for analysis and characterisation of hazardous wastes. Accordingly, CPCB has brought out a laboratory manual on "Analysis and Characterisation of Hazardous Wastes", through a collaborative project with Environment Protection Training and Research Institute (EPTRI), Hyderabad and with input from the State Pollution Control Boards (SPCBs) during the interaction meet-cum-training programme sponsored by CPCB at EPTRI. The manual contains aspects related to standard sampling procedures, analytical procedures for inorganic & organic parameters, methods for determining hazard characteristics of waste and listing of instruments required thereof.

My colleagues Sh. S.S. Pal, Scientist 'B', Dr. Inamul Haq, Senior Scientist and Shri N.K. Verma, Additional Director from Pollution Control Implementation Division and Shri V. Gangal, Scientist 'B', Shri A. Manoharan, Scientist 'C' and Dr. S.D. Makhijani, Additional Director from Laboratory Division were involved in evaluation and finalisation of the manual under the guidance of Dr. B. Sengupta, Member Secretary. Efforts of EPTRI, Hyderabad is acknowledged for organising the interaction meet and hands-on training programme.

We hope, this manual on "Analysis and Characterisation of Hazardous Waste" will be useful to the hazardous waste generators, operators of facilities, regulatory bodies and others involved in hazardous waste management activities.



**Dilip Biswas**  
**Chairman, CPCB**

## CHAPTER 1

# REGULATORY FRAMEWORK AND SCOPE OF THE MANUAL

### 1.1 REGULATORY FRAMEWORK

The Ministry of Environment & Forests, Government of India has promulgated the Hazardous Waste (Management & Handling) Rules, 1989 under the aegis of Environment (Protection) Act, 1986 and subsequently amended to the Rules in the year 2000.

According to the Rule "hazardous wastes" means, -

- (a) Waste Substances, which are generated in the process indicated in Column-2 of Schedule-1 and consists of wholly or partly of the waste substances, referred to in column-3 of the same schedule.
- (b) Waste substances, which consists wholly or partly of substances indicated in Schedule-2, unless the concentration of the substances is less than the limit indicated in the same schedule.
- (c) Waste substances indicated in Part-A, List 'A' and 'B' of Schedule-3 applicable only to rule 12, 13 and 14 unless they do not possess any of the hazardous characteristics in Part-B of the same schedule.

### 1.2 SCOPE OF THE MANUAL

In the light of the provisions made under the Hazardous Wastes (Management and Handling) Amendment Rules, 2000, CPCB intends to prepare a protocol cum guidance manual for the analysis and characterisation of hazardous wastes as per the schedules of the rules.

After a detailed survey of literature in respect of recommended and established methods for analysis and characterisation of hazardous wastes, test methods and analytical procedures for various physico-chemical parameters as applicable to the waste substances identified in Schedule -2 and hazardous characteristics identified in Schedule - 3 are proposed in this manual. However, for certain analytes in waste substances of Schedule -2, established methods or procedures are not available. Hence, classical or instrumental methods of analysis for some such analytes are taken from other references and are proposed in this manual. Though this manual provides the detailed test procedures for the recommended or established methods, references for the alternate methods of analysis for the same analyte are suggested wherever possible.

However, the selection of testing method must be judged strictly on the basis of the technical aspects involved and objective(s) of the analysis requirements. This is keeping in view of the availability of more than one test method for the analysis of many individual chemical parameters and also the requirement of the application of specific test methods and procedures based on the sample conditions such as sample matrix, etc. Hence, any test method(s) applicable for the analysis of a parameter(s) can be adopted provided the test methods are properly validated according to the quality control and assurance norms.

## CHAPTER 2

# SAMPLING CONSIDERATIONS

### 2.1 INTRODUCTION

The initial and perhaps most critical element in a program designed to evaluate the physical and chemical properties of a waste is the plan for sampling the waste. It is understandable that analytical studies, with their sophisticated instrumentation and high cost, are often perceived as the dominant element in the waste characterisation programme. Yet, despite that sophistication and high cost, analytical data generated by a scientifically defective sampling plan have limited utility, particularly in the case of regulatory proceedings.

This section of the manual addresses the development and implementation of a scientifically credible sampling plan for different kinds of wastes and the documentation of the chain of custody for such a plan. The information presented in this section is relevant to the sampling of any hazardous waste, which has been defined in the regulations for the identification and listing of hazardous wastes to include solid, semisolid, liquid, and other materials. However, the physical and chemical diversity of those materials, as well as the dissimilarity of storage facilities (lagoons, open piles, tanks, drums, etc.) and sampling equipment associated with them, preclude a detailed consideration of any specific sampling plan.

An appropriate sampling plan for a waste must be responsive to both regulatory and scientific objectives. Once those objectives have been clearly identified, a suitable sampling strategy, predicated upon fundamental statistical concepts, can be developed<sup>1</sup>.

Any hazardous waste management system requires that the wastes be analyzed for physical and chemical properties. It is mostly chemical properties that are of concern and in the case of a number of chemical contaminants, the MoEF has promulgated regulatory thresholds that cannot be equaled or exceeded. Analysis and characterisation of hazardous wastes also involve the important aspect of the collection of representative samples of wastes for the estimation of analytical properties.

### 2.2 SELECTING SAMPLING PROCEDURES

Sampling is the physical collection of a representative portion of whole of a waste and the basic principle underlying the collection of representative sample is to ensure that the sample being collected exhibits the average properties of the whole or the bulk of the waste. To be representative, a sample must be collected and handled by means that will preserve its original

physical form and composition, as well as prevent contamination or changes in concentration of the parameters to be analyzed. This can be achieved only by means of adopting appropriate sampling plan, methodology, technique and use of suitable sample collection equipment. For a sample to provide meaningful data, it is imperative that it reflects the average properties of the whole of the waste from which it is obtained, its physical and chemical integrity be maintained and that it will be analyzed within a well defined quality control and assurance programme.

Due to the diversity of the wastes and the waste storage and management scenarios, it is obvious that the sampling procedures and techniques to be employed will also vary. Proper procedures and considerations for sample collection, preservation, sample transportation, quality assurance and quality control and occupational health and safety aspects are presented in the following sections. In general, USEPA prescribed methods<sup>2</sup> sourced from SW-846 are presented in this manual.

### **2.2.1 Sampling Strategies**

The development and application of a sampling strategy is a prerequisite to obtaining a representative sample capable of producing scientifically viable data. These strategies should be selected or prepared prior to actual sampling to organize and coordinate sampling activities, to maximize data accuracy, and to minimize errors attributable to incorrectly selected sampling procedures. At a minimum, a sampling strategy should address the following

- Objectives of collecting the samples
- Sampling approach (e.g. Authoritative or Random)
- Types of samples needed (e.g. grab or composite)
- Selection of sampling locations
- Number of samples
- Sampling frequency
- Sample collection and handling techniques to be used
- Physical and Chemical Properties of the wastes
- Special circumstances or considerations (e.g., complex multi-phasic waste streams, highly corrosive liquids, etc.)

### **2.2.2 Planning for Sampling**

Hazardous wastes are complex and heterogeneous with a variety of physical and chemical properties. The waste samples are usually collected from tanks, drums, ponds, piles or from various processing or transporting

equipment such as conveyor belts. It is important that representative sampling be performed. To ensure representative sampling, a sampling plan or protocol is required which ensures that the correct number of samples will be taken at an appropriate frequency and which minimizes sample loss or degradation. A sampling plan should be prepared before the sampling is started to cover the objective, locations and sample size, etc discussed above. The sampling plan should also address the proper use of descriptions, the number, frequency of sampling, decontamination procedures, and handling methods. Depending on whether the waste to be sampled is a liquid, solid, paste, sludge or some combination thereof the sampling methodologies differ. Multiple samples are usually taken in order to determine a statistical average.

### **2.2.3 Sampling Programme Objective**

The objective of sampling is to collect a portion of material small enough in volume to be transported conveniently and handled in the laboratory while still accurately representing the material being sampled. This implies that the relative properties or concentrations of all pertinent component will be the same in the samples as in the material being sampled and that the sample will be handled in such a way that no significant changes in composition occur before the tests are made.

Best analytical methods are of no value if poor sampling techniques are employed. The sample must be representative of the particular substance to be examined and the concentration of the constituent of interest must remain the same until the analytical tests are made. The techniques of sampling vary depending on the type of substances and their uses. Proper location of sampling points and auxiliary equipment is important. In addition, methods of sampling and types of samples are very important.

### **2.2.4 Number of Samples**

Analysis of a large number of samples may, in general, be required to obtain meaningful compositional data since hazardous samples are typically heterogeneous. The number of individual samples that should be analyzed will depend on the kind of information required by the investigation. If an average compositional value is required, a large number of randomly selected samples may be obtained, combined and blended to provide a reasonable homogeneous composite sample from which a sufficient number of sub-samples are analyzed. If composition profiles or the variability of the sample population is of interest, many samples will need to be collected and analyzed individually.

In general, the number of samples and the quality of the sampling procedure must be planned to facilitate characterizing the population of interest and enhance reliability in the final results. If the sampling plan is not specified, the

investigator will need to decide what error and confidence levels are tolerable. Once these are determined, the minimum number of samples necessary for specific confidence limits that satisfy the requirement of the measurement problem can be estimated. Several approaches for defining the number of such samples may be used.

### **2.2.5 Sampling Equipment**

In general, selection of appropriate sampling equipment depends on the physico-chemical properties of the waste. Specific physical parameters affecting this selection include whether the wastes are free flowing or highly viscous liquids, crushed, powdered or whole solid matrices, contained in soils, open dumps, etc.

Chemical properties of the waste also significantly influence the selection of equipment. The person collecting the sample should ensure that the sampling equipment is constructed of materials that are not only compatible with wastes, but are not susceptible to reactions that might alter or bias the physical or chemical characteristics of the waste.

Some times, sampling equipment could be waste specific (e.g., oily sludges) or site-specific, i.e., factors such as accessibility to the site, etc. Hence, in such situations, the type of sampling equipment chosen may have to be properly modified for its applications in such situations.

Keeping in view of the requirements of sampling strategies along with the physical, chemical, waste and site specific factors associated with the waste to be sampled standard procedures for the sample collection are presented below.

## **2.3 STANDARD PROCEDURES FOR SAMPLE COLLECTION (SOLID/SEMI-SOLID/SLUDGE/OIL)**

Samples should be collected under the supervision of a qualified Environmental Engineer, Geologist and concerned Chemist/Scientist.

### **2.3.1 Selection of Sampling Approach**

Select a suitable sampling approach based on the applicability and associated advantages/ disadvantages as detailed in Table-2.1.

### **2.3.2 Selection of Type of Samples**

Decide the types of samples to be collected from different waste streams based on the applicability and associated advantages/disadvantages as detailed in Table-2.2.



**Table 2.1  
Sampling Approach Overview**

<b>Sampling Strategy</b>	<b>Definition</b>	<b>Applicability</b>	<b>Advantages/Disadvantages</b>
Authoritative	Technique where sample locations are selected based on detailed knowledge of the waste stream without regard to randomization.	Waste streams of known physical/chemical properties and concentrations.	Requires in-depth knowledge of properties and constituents of waste streams. Rationale for sample selection must be well documented and defensible.
Random (Simple, Stratified, systematic)	Techniques where sample selection and location are determined through the application of statistical methods.	Used to collect representative samples where data is insufficient to justify authoritative sampling (e.g., waste streams of unknown or variable concentration).	See discussions below for each respective random sampling technique.
Simple Random	All locations/points in a waste or unit from which a sample can be attained are identified, and a suitable number of samples are randomly selected.	Used to collect representative samples of wastes that are heterogeneous throughout the entire waste stream or unit (e.g., multiple drums of unknown origin).	Advantages: Most appropriate when little or no information is available concerning the distribution of chemical contaminants.  Disadvantages: May misrepresent waste streams with areas of high concentration or stratification.
Stratified Random	Areas of non-uniform properties or concentrations are identified and stratified (segregated). Subsequently, simple random samples are collected from each stratum of the waste or unit.	Used to collect representative samples from waste or units that are known to have areas of non-uniform properties (strata) or concentration (hot spots) e.g., surface impoundment with multiple waste layers.	Advantages: Provides for increased accuracy of waste streams representation if strata or a typically high or low concentration area is present. Disadvantages: Requires greater knowledge of waste stream than for simple random sampling and may require sophisticated statistical applications.
Systematic Random	The first sampling point is randomly selected but all subsequent samples are collected at fixed space intervals (e.g., along a transect or time intervals).	An alternate procedure used to collect representative samples from modestly heterogeneous waste streams that provide for simplified sample identification.	Advantages: Provides for easier sample identification and collection than other techniques.  Disadvantages: May misrepresent waste streams with unknown areas of high concentration or stratification.

**Table 2.2**  
**Major Sample Types**

<b>Sampling Strategy</b>	<b>Definition</b>	<b>Applicability</b>	<b>Advantages/Disadvantages</b>
<b>Grab</b>	A sample taken from a Particular location at a distinct point in time.	Most common type used for random sampling. Useful in determining waste streams variability (e.g., range of concentration) when multiple or frequent samples are obtained.	<u>Advantages:</u> Simplest technique, best measure of variability. <u>Disadvantages:</u> May require large number of samples than composting to obtain representative sample.
<b>Composite*</b>	A number of individually collected samples that are combined into a single sample for subsequent analysis.	Used where average or normalized concentration estimates of a waste stream's constituents are desired.	<u>Advantages:</u> Reduce analytical costs. May reduce the number of samples needed to gain accurate representation of a waste. <u>Disadvantages:</u> Only provides the average concentrations of a waste stream (i.e., information about concentration range is lost).

\* A large number of composite samples or splitting of the composites is recommended for replicate measurement. Cone and quartering is an effective method for homogenizing bulk solid samples. The sample is poured into a cone, which is flattened and quartered. The process is repeated until homogeneity is achieved. The riffle splitter is another commonly used method. The waste is repeatedly poured through the splitter and halves are combined between passes. This method is more efficient with less loss fines and is therefore recommended to homogenize bulk soil samples.

### **2.3.3 Selection of the Sampling Equipment**

Applicability of various kinds of sampling equipment and recommended sample containers to hazardous wastes for the wastes to be sampled in different environments is presented in Tables **2.3 and 2.4**. Figures and dimensions of sampling equipment are presented in Figs. **2.1 to 2.6**.

A brief description of the sample collection equipment is presented below.

#### **Composite Liquid Waste Sampler (Coliwasa)**

The Coliwasa is a device employed to sample free-flowing liquids and slurries contained in drums, shallow tanks, pits, and similar containers. It is especially useful for sampling wastes that consist of several immiscible liquid phases. The equipment consists of a glass, plastic, or metal tube equipped with an end closure that can be opened and closed while the tube is submerged in the material to be sampled (Refer Fig. 2.1).

#### **Weighted Bottle**

This sampler consists of a glass or plastic bottle, sinker, stopper and a line that is used to lower, raise and open the bottle. The weighted bottle is used for the collection liquids and free-flowing slurries (Refer Fig. 2.2).

#### **Dipper**

The dipper consists of a glass or plastic beaker clamped to the end of a two- or three-piece telescoping aluminum or fiberglass pole that serves as the handle. A dipper is used for the collection of liquids and free-flowing slurries (Refer Fig. 2.3).

#### **Thief**

A thief consists of two slotted concentric tubes, usually made of stainless steel or brass. The outer tube has a conical pointed tip that is rotated to open and close the sampler. A thief is used to sample dry granules or powdered wastes whose particle diameter is less than one-third the width of the slots. This equipment can be procured from any suppliers of laboratory items (Refer Fig. 2.4).

#### **Trier**

A trier consists of a tube cut in half lengthwise with a sharpened tip that allows the sampler to cut into sticky solids and to loosen soil. A trier is used for the collection of moist samples or sticky solids with a particle diameter less than one-half diameter of the trier. Some kinds of triers can be readily procured from the suppliers of the laboratory items and hardware shops or triers can be

fabricated as per the required dimensions. (Refer Fig. 2.5)

### **Auger**

An auger consists of sharpened spiral blades attached to a hard metal central shaft. An auger samples hard or packed solid wastes or soil. Augers can be procured from hardware shops and suppliers of the laboratory items. (Refer Fig. 2.6)

### **Scoops and Shovels**

Scoops and shovels are used for the collection of granular or powdered material in bins, shallow containers and conveyor belts. Scoops are available at hardware and suppliers of the laboratory items.

**Table 2.3**

**Applicability of Sampling Equipment to Waste Streams, Waste Location or Container**

Waste Type	Drum	Sacks and Bags	Open-Bed Truck	Closed Bed Truck	Storage Tanks Or Bins	Waste Piles	Ponds, Lagoons & Pits	Conveyor Belt	Pipe
Free-flowing liquids and slurries	Coliwas a	N/A	N/A	Coliwas a	Weighted bottle <sup>a</sup>	N/A	Dipper	N/A	Dipper
Sludges	Trier	N/A	Trier	Trier	Trier	a	A	b	b
Moist powders or granules	Trier	Trier	Trier	Trier	Trier	Trier	Trier	Shovel	Dipper
Dry powders or granules	Thief	Thief	Thief	Thief	a	Trier	Thief	Shovel	Dipper
Sand or packed powders and granules	Auger	Auger	Auger	Auger	Thief	Thief	A	Dipper	Dipper
Large grained solids	Large Trier	Large Trier	Large Trier	Large Trier	Large Trier	Large Trier	Large Trier	Trier	Dipper

<sup>a</sup>This type of sampling situation can present significant logistical sampling problems, and sampling equipment must be specifically selected or designed based on site and waste conditions. No general statement about appropriate sampling equipment can be made.

**Table 2.4****Samplers Recommended for Various Types of Waste**

<b>Waste type</b>	<b>Recommended sampler</b>	<b>Limitations</b>
Liquids, sludges, and slurries in drums, vacuum trucks, barrels, and similar containers	Coliwasa Plastic Glass	Not for containers 1.5 m (5ft) deep  Not for wastes containing ketones, nitrobenzene, dimethyl formamide or tetrahydrofuran. etc.  Not for wastes containing hydrofluoric acid and concentrated alkali solutions.
Liquids and sludges in ponds, pits, or lagoons	Pond	Cannot be used to collect samples beyond 3.5 m (11.5ft). Dip and retrieve sampler slowly to avoid bending the tubular aluminium handle.
Powdered or granular solids in bags, drums, barrels, and similar containers	a) Grain sampler  b) Sampling Trier	Limited application for sampling moist and sticky solids with a diameter 0.6 cm (1/4 in.)  May incur difficulty in retaining core sample of very dry granular materials during sampling.
Dry wastes in shallow containers and surface soil	Trowel or scoop	Not applicable to sampling deeper than 8cm (3 in.). Difficult to obtain reproducible mass of samples.
Waste piles	Waste pile sampler	Not applicable to sampling solid wastes with dimensions greater than half the diameter of the sampling tube.
Soil deeper than 8cm (3 in.)	a) Soil auger  b) Veihmeyer sampler	Does not collect undisturbed core sample.  Difficult to use on stony, rocky, or very wet soil.
Wastes in storage tanks	Weighted bottle sampler	May be difficult to use on very viscous liquids.

Source USEPA "Samplers And Sampling Procedures For Hazardous Waste Streams, Jan 1980

**FIGURE 2.1**  
**Composite Liquid Waste Sampler (Coliwasa)**

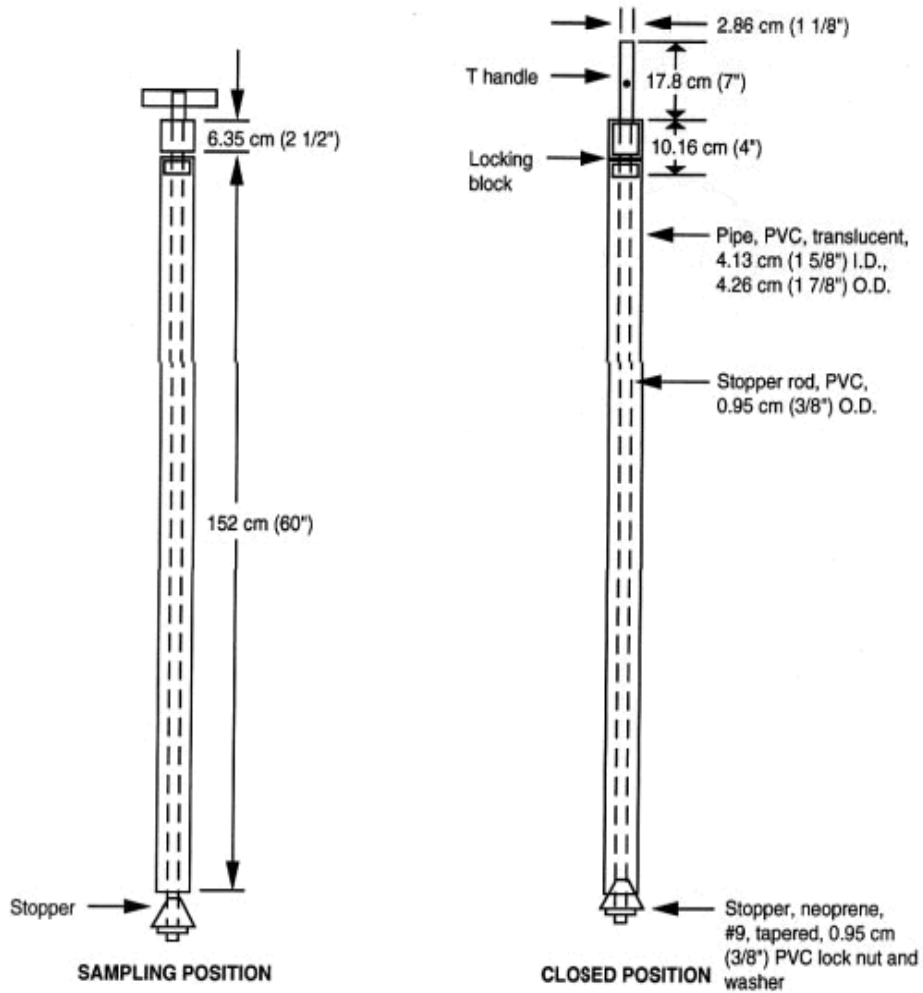

**FIGURE 2.2**  
**Weighted Bottle**

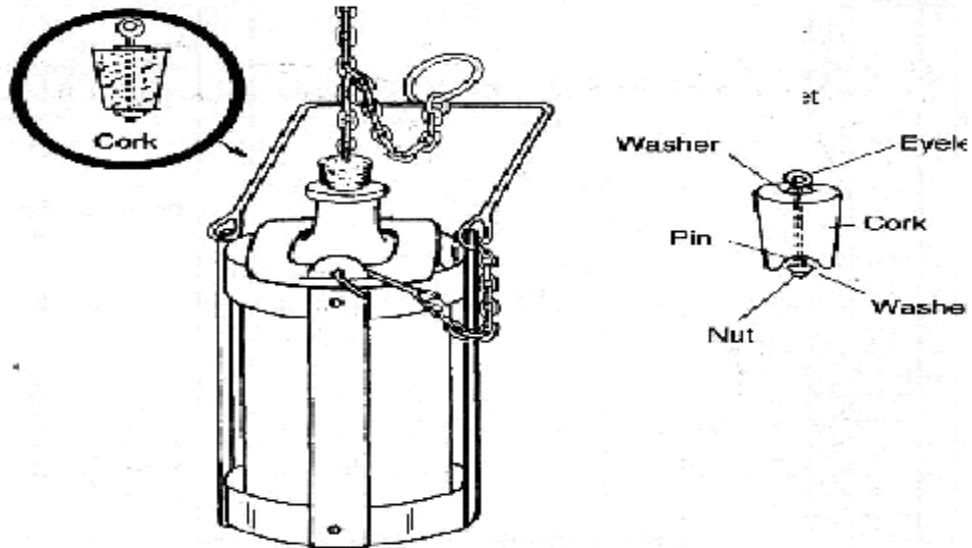

**FIGURE 2.3**  
**Dipper**

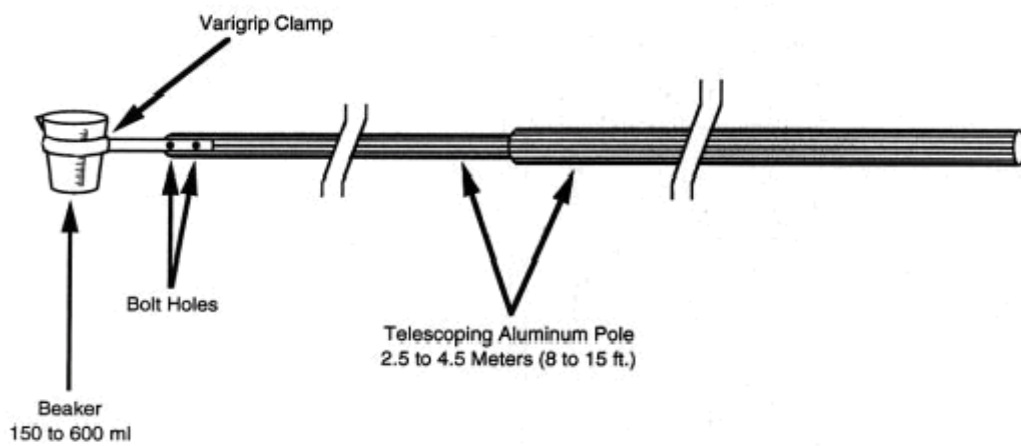
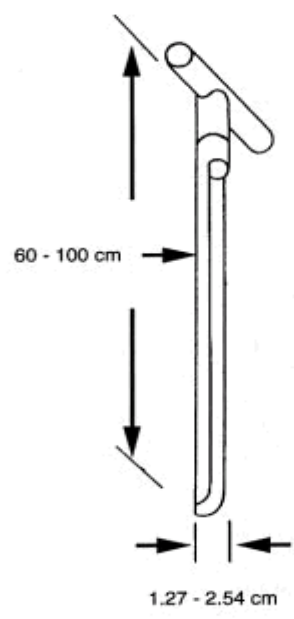
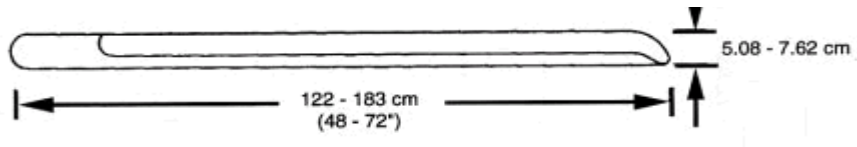
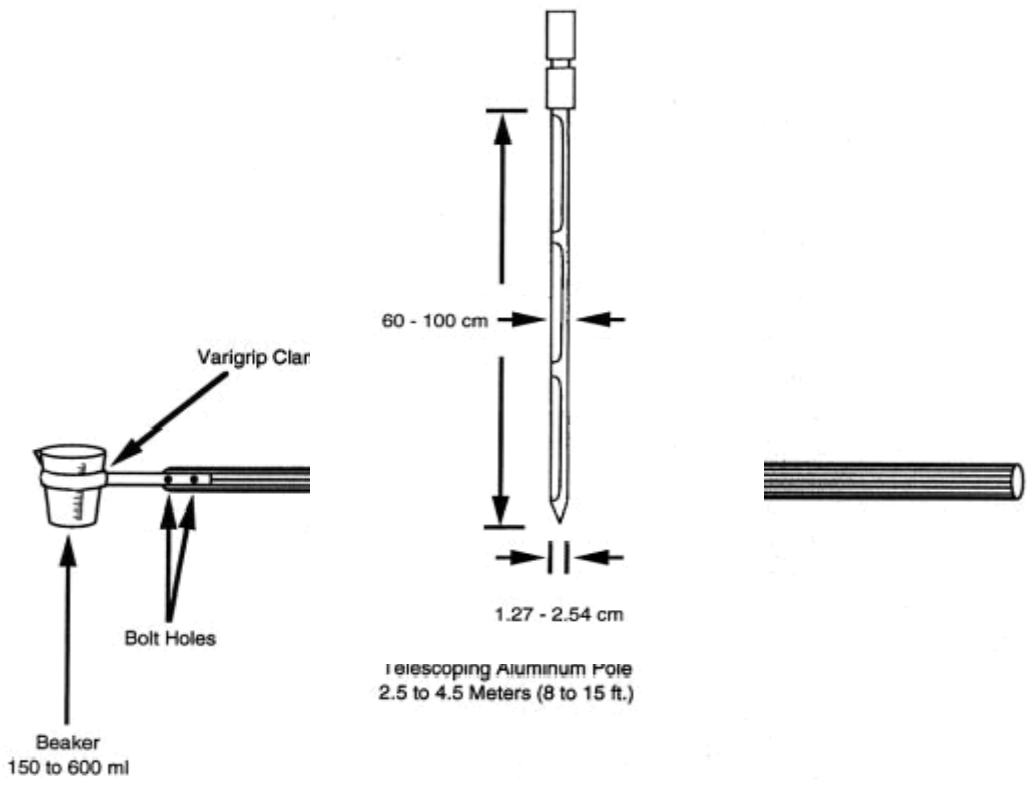
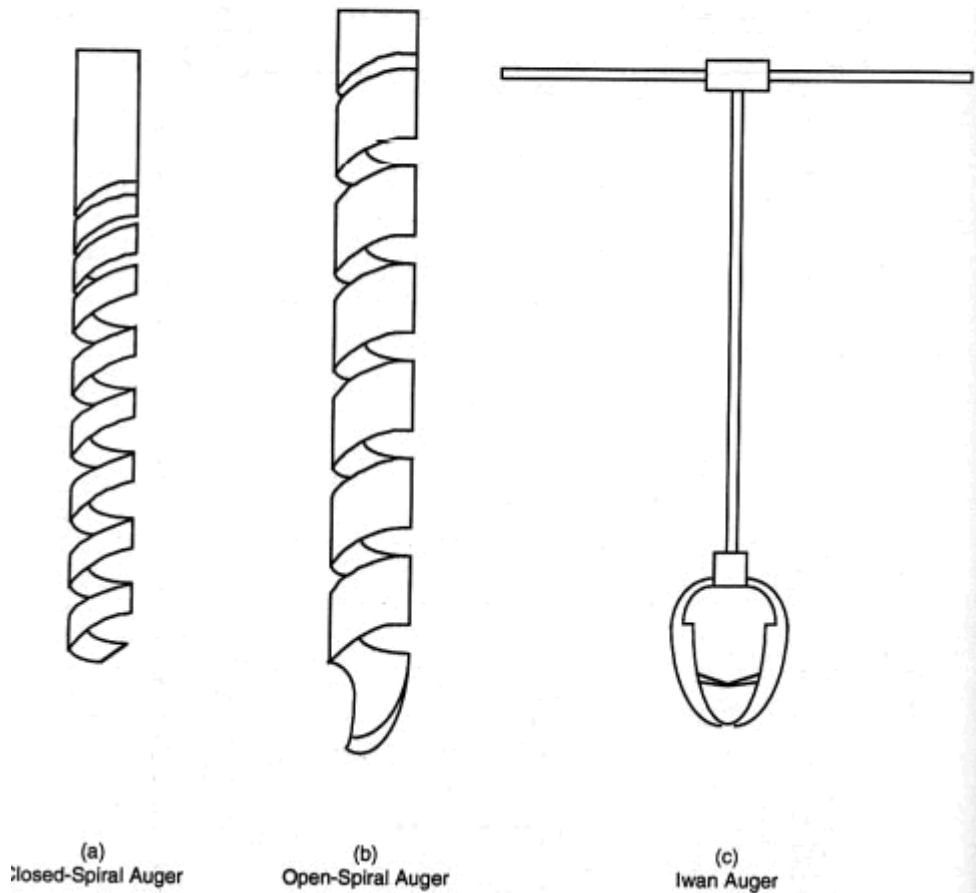



FIGURE 2.4



**FIGURE 2.6**  
**Hand Augers**



#### **2.3.4 Sample Collection Equipment--Other Considerations**

The choice of sampling equipment and sample containers will depend upon the previously described waste and site considerations. The following aspects should be carefully examined while suggesting the suitability of sample collection equipment.

- The potential interactions between sampling equipment or container material with analytes of interest in the waste to be sampled must be carefully examined and materials that minimizes losses by adsorption, volatilization or contamination must be selected as sampling equipment and sample containers.

- Prior to the initial sampling location and between subsequent sampling locations, decontamination procedures should be followed strictly to prevent the introduction of contaminants, viz., negative, positive and cross contamination by the sampling equipment. The decontamination procedure consists of the following steps:
1. Steam clean or scrub all equipment with a non-phosphate detergent.
  2. Rinse with tap water.
  3. Rinse twice with de-ionized or distilled water.
  4. Retrieve the sample, record the details of samples like, quantity, locations, depth, and nearby water bodies to survey the contamination.
  5. The minimum sample volume required is specified by the analytical laboratory based on the selected method and required sensitivity of the analysis, and should be verified with the laboratory to ensure that adequate sample volume is obtained.
  6. Sample homogenization (i.e., collection of composite samples) should not be performed on samples intended for volatile or semi volatile organics analysis since the mechanical action of mixing exposes a larger surface area of the waste to the air, thus increasing the total amount of volatilization.

### **2.3.5 Containerization, Preservation and Holding Times of Samples**

Selection of appropriate container systems, preservation and transport of samples constitute an important aspect in planning the sampling strategies. The most important factors to consider when choosing containers for hazardous waste samples are compatibility with the waste, cost, and resistance to breakage and volume. Containers must not distort, rupture, or leak as a result of chemical reactions with constituents of waste samples. Thus, it is important to have some idea of the properties and composition of the waste. The containers must have adequate wall thickness to withstand handling during sample collection and transport to the laboratory. Containers with wide mouths are often desirable to facilitate transfer of samples from samplers to containers. Also, the containers must be large enough to contain the optimum sample volume.

Containers for collecting and storing hazardous waste samples are usually made of plastic or glass. Plastics that are commonly used to make the containers include high-density or liner polyethylene, conventional polyethylene, polypropylene, polycarbonate, Teflon FEP (fluorinated ethylene propylene), polyvinyl chloride (PVC) or polymethylpentene. Teflon FEP is almost universally usable due to its chemical inertness and resistance to breakage. However, its high cost severely limits its use. LPE (Liner Polyethylene), on the other hand, usually offers the best combination of

chemical resistance and low cost when samples are to be analyzed for inorganic parameters.

Glass containers are relatively inert to most chemicals and can be used to collect and store almost all hazardous waste samples, except those contain strong alkali and hydrofluoric acid. Glass soda bottles are suggested due to their low cost and ready availability. Borosilicate glass containers such as Pyrex and Corex, are more inert and more resistant to breakage than soda glass, but are expensive and not always readily available. Glass or FEP containers must be used for waste samples that will be analyzed for organic compounds.

The containers must have tight, screw-type lids. Plastic bottles are usually provided with screw caps made of the same material as the bottles. Buttress threads are recommended. If the samples are to be submitted for analysis of volatile compounds, the samples must be sealed in airtight containers.

Appropriate containers with an appropriate lid type should be used for storing and transporting samples. Refer Table 2.5 as applicable to the Schedule 2 and 3 of the rules for containers, preservation techniques, and holding times for aqueous matrices.

Samples containing light sensitive organic contaminants should be stored in amber glass bottles with appropriate lids.

Samples of an aqueous or solid matrix intended for organic analysis should be stored in glass bottles with appropriate lids or lined caps. In general, a sample size of 1kg of solid is required for a complete comprehensive analysis. If the sample is in the form of sludge or slurry, ensure that the content of solids in the sample collected is at least 1 kg.

Measure/fix the parameters of importance like pH, sulfides, nitrites, at field itself.

Preservatives should be added depending upon the parameters at the site itself as indicated at Table 2.5.

**Table 2.5**

**Containers, Preservation Techniques, and Holding Times for Aqueous Matrices<sup>A</sup>**

<b>S.No.</b>	<b>Parameters</b>	<b>Containers</b>	<b>Preservation</b>	<b>Maximum holding time</b>
A10	Cyanide, total and amenable to chlorination	P,G	None required	28 days
C12	Nitrates	P, G	Cool to 4 <sup>0</sup> c; If oxidizing agents present add 5 ml of 0.1 n NaAsO <sub>2</sub> per l or 0.06 g of ascorbic acid per l; adjust pH >12 with 50%NaOH	14 Days
C13	Sulfide	P, G	Cool to 4 <sup>0</sup> c, add Zinc acetate	7 Days
A5	Chromium (6)	P, G	Cool to 4 <sup>0</sup> c.	24 hours.
A6	Mercury	P, G	HNO <sub>3</sub> to pH <2	28 days
A1, A2, A3, A4, A5, A8, A9, B2, B3, B4, B5, B6, B7, B8, B9, B10, C3, C14	Sb, As, Be, Cd, Se, Te, Th, Co, Cu, Pb, Mo, Ni, Sn, W, V, Ag, Ba, Zn	P, G	HNO <sub>3</sub> to pH <2	6 Months
A17	Halogenated hydrocarbons	G, PTFE-lined septum	Cool to 4 <sup>0</sup> c.	7 days until extraction.
B14	Nitro and nitroso compounds	G, PTFE-lined cap (Teflone)	Cool to 4 <sup>0</sup> c.0.008% Na <sub>2</sub> S <sub>2</sub> O <sub>3</sub> <sup>3</sup>	7 days until extraction. 40 days after extraction.

**Table 2.5 (Contd.)**

**Containers, Preservation Techniques, and Holding Times for Aqueous Matrices<sup>A</sup>**

A19	Dieldrin, Aldrin, Endrin.	G, PTFE-lined cap	Cool to 4 <sup>o</sup> c	7 days until extraction. 40 days after extraction.
A16	Polychloro Biphenyls	G, PTFE-lined cap	Cool to 4 <sup>o</sup> c	7 days until extraction. 40 days after extraction.
B19	Phenols	G, PTFE-lined cap	Cool to 4 <sup>o</sup> c 0.008% Na <sub>2</sub> S <sub>2</sub> O <sub>3</sub> <sup>3</sup>	7 days until extraction. 40 days after extraction.
A12, A13, A14, A15	PAHs	G, PTFE-lined cap	Cool to 4 <sup>o</sup> c 0.008% Na <sub>2</sub> S <sub>2</sub> O <sub>3</sub> <sup>3</sup>	7 days until extraction. 40 days after extraction.
A17	Halogenated organic compounds.	G, PTFE-lined cap	Cool to 4 <sup>o</sup> c 0.008% Na <sub>2</sub> S <sub>2</sub> O <sub>3</sub> <sup>3</sup>	14 days.
	Hydrogen ion (pH)	P, G	None required.	24 hours.
	Oil & grease	G	Cool to 4 <sup>o</sup> c	28days.
	Organic carbon, total (TOC)	P, G	Cool to 4 <sup>o</sup> C, store in dark.	28 days.

\*P-polyethylene; \*G-glass, \* PTFE - Teflon

Ref: Table-2-34, rev-4 98,USEPA-SW846.

Each sample should be labeled in sequence, then individually placed in polypropylene or glass containers. Sample analysis request form should accompany each batch of samples to the laboratory.

Refrigerate the samples like non-liquids (i.e., solids, sediments, sludges) and liquid samples for non-volatile organic analysis at specified temperatures. Transport the samples to the selected analytical laboratory as soon as possible. If the samples cannot be submitted to the selected analytical laboratory in a reasonable period of time, enough care must be taken to ensure the integrity of sample, such as storing the samples at the specified temperatures during transportation, etc.

### **2.3.6 Sample collection, preservation, and handling for sulfide and cyanide bearing wastes**

Samples containing, or suspected of containing, sulfide or a combination of a sulfide and cyanide wastes should be collected with a minimum of aeration. The sample bottle should be filled completely, excluding all head space, and stoppered. Analysis should commence as soon as possible, and samples should be kept in a cool, dark place until analysis begins.

It is suggested that samples of cyanide wastes be tested as quickly as possible. Although they can be preserved by adjusting the sample pH to 12 with strong base, this will cause dilution of the sample, increase the ionic strength, and, possibly change other physical or chemical characteristics of the waste, which may affect the rate of release of the hydrocyanic acid. Storage of samples should be under refrigeration and in the dark.

## **2.4 QUALITY ASSURANCE AND QUALITY CONTROL**

Quality assurance (QA) is the process for ensuring that all data and the decisions based on these data are technically sound. Appropriate QA and QC procedures as relevant to the rules should be followed throughout the sampling process. Quality control (QC) procedures are the tools employed to measure the degree to which these quality assurance objectives are met. Keeping in view of the Schedules 2 and 3 of the rules, the following QA and QC procedures must be followed.

Quality control procedure that must be employed to document the accuracy and precision during sample collection is to collect field duplicates. Field duplicates must be collected at the rate of one field duplicate for every 20 samples of a batch and for each kind of waste to document precision. Standard statistical approaches may be followed for deciding the number of field duplicates in cases of less number of samples and collection of samples of dissimilar nature. (Refer "Test Methods for Evaluating Solid Waste", Volume II: Field Manual Physical/Chemical Methods, SW-846, USEPA.)

In addition, the following must be followed as part of QA programme during sampling.

## 1. Chain of Custody

The possession and handling of samples should be traceable from the time of collection through analysis and final disposition at the analytical laboratory. This include, sample seals (in case of legal samples), field logbook, and sample analysis request sheet.

Sample must be labelled properly. Gummed paper labels or tags are adequate. Labels should be affixed to sample containers prior to or at the time of sampling and should be filled out at the time of sample collection only. Labelling of samples must be legible and clear. Minimum information required on the label is

- Sample Number
- Name of Collector
- Date and Time of Collection
- Details of Sampling Location

All information pertinent to a field survey or sampling must be recorded in the logbook. Sample collection logbook must be properly maintained and should be made available for necessary inspection. At a minimum, entries in the logbook must include the following:

- Location of sampling point
- Name and address of field contact
- Producer of waste and address
- Type of process producing waste (if known)
- Type of waste (liquid, solid, semi-solid, sludge, etc.)
- Suspected waste composition
- Number and volume/quantity of sample collected
- Purpose of sampling
- Description of sampling point and sampling methodology
- Date and time of sample collection
- Sample Identification numbers at the time of sample collection
- Field observations and field measurements made (if any)
- Details of sample preservation conditions
- Identity and signatures of personnel responsible for sample collection and observations

In addition, for chain of custody purposes, all relevant data must be recorded and the record should contain the following.

1. Sample number
2. Signature of collector



3. Date and time of collection
4. Place and address
5. Waste Type
6. Signature of persons involved in the chain of possession (inclusive dates of possession)

Sample analysis request sheet duly authorized and signed by a responsible person should accompany the sample on delivery to the laboratory. Format of sample analysis request sheet is presented at Table 2.6. The field portion of this form must be completed by the person collecting the sample and should include most of the pertinent information noted in the logbook. The laboratory portion of this form is intended to be completed by laboratory personnel and to include the following.

1. Name of person receiving the sample
2. Laboratory Sample Number
3. Date and time of sample receipt
4. Sample Allocation
5. Analyses to be performed.

The sample should be delivered to the laboratory for analysis as soon as possible. The sample must be accompanied by the chain-of-custody record and by a sample analysis request sheet. The sample must be delivered to the person in the laboratory authorized to receive samples.

## **2.5 HEALTH AND SAFETY**

Safety and health must also be considered when implementing a sampling plan. A comprehensive health and safety plan must include the following elements.

### **2.5.1 Routine Safety Procedures**

Monitoring personnel should be properly trained and they must be made aware of the common routes of exposure to chemicals, i.e., inhalation, contact and ingestion.

Monitoring personnel should be instructed in the proper use of safety equipment, protective clothing and respiratory equipment.

Protocols must be defined stating when safety equipment should be employed and designating safe areas where facilities are available for washing, drinking and eating.

## 2.5.2 Preventive Measures For Laboratory Hazards Along With Safety Devices

In the event of an emergency arising out of unanticipated explosion, electrical hazard, fall or exposure to a hazardous substance, emergency procedures must be followed as given below.

Field personnel should be aware of basic first aid and have immediate access to a first-aid kit.

Phone numbers for both police and the nearest hospital should be made available to each member of the monitoring team.

Any team member suffering an injury or accident should be shifted to the nearest hospital with necessary feed back to the hospital management.

*Every laboratory conducting hazardous waste characterization as per the rules for compliance must prepare standard operating procedures (SOPs) covering all the above aspects.*

**TABLE 2.6**

### **SAMPLE ANALYSIS REQUEST SHEET**

#### **I. FIELD SECTION**

1. Name of Location :
2. Nature of Sample (Grab/Composite) :
3. Sample(s) Collected by :
4. Date and Time of Sample Collection :
5. Sample(s) Submitted by :
6. Address of authorized person for sample Collection or Submission or Client (with Telephone nos., etc.) :

Laboratory Sample Number	Sample No. as given at the site	Type of Sample (liquid, solid, sludge, etc.)	Field Information

7. Analysis Requested
8. Specific handling and/or storage requirements :  
(if any)  
Sample Collected by: \_\_\_\_\_ Date: \_\_\_\_\_



## CHAPTER 3

# GROUPING OF CHEMICAL SUBSTANCES OF SCHEDULE 2 HAZARDOUS WASTE (MANAGEMENT & HANDLING) AMENDMENT RULES 2000

### 3.1 INTRODUCTION

Hazardous Wastes (Management & Handling) Amendment Rules, 2000 includes three schedules. Schedule 1 of the Rules refers to List of Processes generating Hazardous Wastes. Schedule 2 of the Rules refers to List of Waste Substances with Concentration Limits and Schedule 3 (Part B) of the Rules refers to List of Hazardous Characteristics.

This manual is intended to provide comprehensive analytical methods and procedures for conducting hazardous waste analysis and characterization as per Schedule 2 and Schedule 3 (Part B). In Schedule 2, chemical substances are divided in to 5 classes, viz., Class A to E with different concentration limits except Class E. Class E refers to characteristics of hazardous wastes rather than concentration(s) of substances.

The chemical substances in Classes A to D can broadly be divided in to two groups, viz., inorganic and organic substances for the convenience of this manual.

Inorganic substances are sub-divided in to the following groups:

1. Chemical substances where metals/metal ions are principle analytes, viz., Antimony and Antimony Compounds (A1), Chromium (III) Compounds (B1), Zinc Compounds (C14), etc. (Refer Annexure - I)
2. Other Inorganic Substances where anions/cations/non-metals/others are principle analytes, viz., Flourine Compounds (C4), Nitrates, Nitrites (C12), Sulfur (D1), Asbestos (B21). (Refer Annexure - I).

Organic substances are sub-divided in to the following groups:

1. Volatile Organic substances
2. Semi-volatile and Non-volatile Organic Substances

Grouping of Schedule 2 substances is presented in **Table 3.1 and Table 3.2**. Table 3.1 refers to inorganic parameters and Table 3.2 refers to organic parameters.

It may be noted that the grouping is made for the purpose of convenience in presenting the subsequent chapters of this manual and the serial numbers given in the Table 3.1 and Table 3.2 do not carry any significance with respect to the rules.

**Table 3.1**  
**List of Inorganic Waste Substances with Concentration Limits -- Schedule - 2**

<b>S. N.</b>	<b>Description</b>	<b>Schedule 2 Reference</b>	<b>Concentration Limit (mg/kg on dry weight basis)</b>	<b>Reference in the Manual</b>
<b>METALS</b>				
1.	Antimony and Antimony Compounds	A1	50	Refer Method 5.4
2.	Beryllium and Beryllium Compounds	A3	50	Refer Method 5.4
3.	Cadmium and Cadmium Compounds	A4	50	Refer Method 5.4
4.	Tellurium and Tellurium Compounds	A8	50	Method not included in this manual
5.	Thallium and Thallium Compounds	A9	50	Refer Method 5.4
6.	Chromium (III) Compounds	B1	5000	Refer Method 5.4
7.	Cobalt Compounds	B2	5000	Refer Method 5.4
8.	Copper Compounds	B3	5000	Refer Method 5.4
9.	Lead and Lead Compounds	B4	5000	Refer Method 5.4
10.	Molybdenum Compounds	B5	5000	Refer Method 5.4
11.	Nickel Compounds	B6	5000	Refer 5.4
12.	Tin Compounds	B7	5000	Refer 5.4
13.	Vanadium Compounds	B8	5000	Refer 5.4
14.	Tungsten Compounds	B9	5000	Method not included in this manual
15.	Silver Compounds	B10	5000	
16.	Barium Compounds except Barium Sulphate	C3	20000	Refer Method 5.4
17.	Zinc Compounds	C14	20000	Refer Method 5.4
18.	Arsenic and Arsenic Compounds	A2	50	Refer Method 5.6
19.	Mercury and Mercury Compounds	A6	50	Refer Method 5.7
20.	Selenium and Selenium Compounds	A7	50	Refer Method 5.6
<b>ANIONS/NON-METALS/OTHERS</b>				
<b>Anions</b>				
1.	Inorganic Cyanide Compounds (Cyanides)	A10	50	Refer Method 5.15
2.	Fluorine Compounds	C4	20000	Refer Method 5.10

<b>S. N.</b>	<b>Description</b>	<b>Schedule 2 Reference</b>	<b>Concentration Limit (mg/kg on dry weight basis)</b>	<b>Reference in the Manual</b>
3.	Phosphorous Compounds, except the phosphates of Aluminum, Calcium and Iron	C5	20000	Refer Method 5.13
3.	Nitrates and Nitrites	C12	20000	Refer Method 5.9 & 5.11
4.	Sulfides	C13	20000	Refer Method 5.14
5.	Bromates, Hypobromates	C6	20000	Method not included in this manual
6.	Chlorates, (Hypo)chlorites	C7	20000	Method not included in this manual
7.	Iodates	C11	20000	Method not included in this manual
	Salts of peracids	C15	20000	Methods not included in this manual
8.	Metalbisulphates	D3	50000	Methods not included in this manual
9.	Nitrides	D8	50000	Method not included in this manual
10.	Hydrides	D9	50000	Method not included in this manual
	<b>Cations</b>			
1.	Ammonia and Ammonium Compounds	C1	20000	Refer Method 5.12
	<b>Others</b>			
1.	Metal Carbonyls	A11	50	Method not included in this manual
2.	Asbestos	B21	5000	Method not included in this manual
	White Phosphorous	B28	5000	Method not included in this manual
3.	Halogen-silanes	B23	5000	Method not included in this manual
4.	Flourine	B25	5000	Refer Method 5.10

S. N.	Description	Schedule 2 Reference	Concentration Limit (mg/kg on dry weight basis)	Reference in the Manual
5.	Chlorine	B26	5000	Method not included with manual
6.	Bromine	B27	5000	- do -
7.	Ferro-silicon and Alloys	B29	5000	Method not included in this manual
8.	Manganese-silicon	B30	5000	Method not included in this manual
9.	Halogen containing substances which produce acidic vapours on contact with damp air or water, e.g., Silicon tetrachloride, Aluminium chloride, Titanium tetrachloride	B31	5000	Method not included in this manual
10.	Inorganic peroxides	C2	20000	Method not included in this manual
11.	Sulfur	D1	50000	
12.	Inorganic acids	D2	50000	
13.	Oxides and hydroxides except those of Hydrogen, Carbon, Silicon, Iron, Aluminium and Titanium, Manganese, Magnesium and Calcium	D4	50000	Method not included in this manual

**Table 3.2**  
**List of Organic Waste Substances with Concentration Limits -- Schedule - 2**

S. No.	Description	Schedule 2 Reference	Concentration Limit (mg/kg on dry weight basis)	Reference in the Manual
1.	Naphthalene	A12	50	Method 6.6
2.	Anthracene	A13	50	Method 6.6
3.	Phenanthrene	A14	50	Method 6.6
4.	Crysene, Benzo (a) anthracene, Fluoranthene, Benzo (a) pyrene, Benzo (k) fluoranthene, Indino (1,2,3-ed) pyrene and Benzo (ghi) perylene	A15	50	Method 6.6

S. No.	Description	Schedule 2 Reference	Concentration Limit (mg/kg on dry weight basis)	Reference in the Manual
5.	Halogenated fused aromatic rings, eg., polychlorobiphenyls plus derivatives	A16	50	Method 6.7
6.	Halogenated aromatic Compounds	A17	50	Method not included in this manual
7.	Benzene	A18	50	Method 6.9
8.	Dieldrin, Aldrin and Endrin	A19	50	Method 6.7
9.	Organotin Compounds	A20	50	Method not included in this manual
10.	Organic Halogen Compounds	B11	5000	- do -
11.	Organic Phosphorous Compounds	B12	5000	- do -
12.	Organic Peroxides	B13	5000	- do -
13.	Organic Nitro- and Nitroso-Compounds	B14	5000	- do -
14.	Organic azo and azo-oxy Compounds	B15	5000	- do -
15.	Nitriles	B16	5000	- do -
16.	Amines	B17	5000	- do -
17.	(Iso- and thio-) cyanates	B18	5000	- do -
18.	Phenol and Phenolic Compounds	B19	5000	Method 6.8
19.	Mercaptans	B20	5000	
20.	Hydrazines	B24	5000	- do -
21.	Aromatic Compounds	C8	20000	Refer method 6.9
22.	Organic Silicon Compounds	C9	20000	Method not included in this manual
23.	Organic Sulphur Compounds	C10	20000	Refer method 6.11
24.	Acid Halides, Acid Amides	C16	20000	- do -
25.	Acid Anhydrides	C17	20000	- do -
26.	Aliphatic and Napthenic Hydrocarbons	D5	50000	- do -
27.	Organic Oxygen Compounds	D6	50000	- do -
28.	Organic Nitrogen Compounds	D7	50000	- do -
29.	Nitrides	D8	50000	- do -
	<b>OTHERS</b>			
	Drilling, Cutting, Grinding and Rolling Oil or Emulsions thereof	B22	5000	



## CHAPTER 6

# METHODS OF ANALYSIS ORGANIC SUBSTANCES - SCHEDULE-2

### 6.1 INTRODUCTION

In this Chapter, test methods for the analysis of organic parameters in the wastes, as applicable to Schedule-2 of the rules, are presented.

### 6.2 ANALYTICAL METHODS

Analysis of waste substances for organic parameters involves, in general, the following steps.

- Sample preparation -- Distillation, Extraction, etc
- Sample Clean Up
- Analytical Determination

In this Chapter, sample preparation and determination methods for the analysis of organic chemical substances listed in Table 3.2 of Chapter 3.3 are presented. The procedures are presented in the form of "Standard Operating Procedures (SOPs)" to the extent possible with appropriate references. Individual laboratories may prepare SOPs and upgrade the manual as per the Quality Systems followed. Additional information may be obtained and incorporated in SOPs by consulting the references indicated and any other standard references as applicable to the analysis of hazardous wastes.

### 6.3 ORGANIC COMPOUNDS

Gas Chromatographic (GC) methods are presented for all organics except phenol Compounds. Colourimetric Method of Analysis is presented for phenol compounds.

Organic substances are divided in to the following groups

- a) Semivolatile organic compounds: In this class procedures for PAH's, Chlorinated pesticides and PCB's are presented. The sample preparation by Soxhlet extraction is presented for all semivolatile organic compounds.
- b) Volatile organic compounds: In this class procedures for aromatic compounds and halogenated volatile organic compounds are presented. The sample preparation and analysis method for volatile organic compounds by Head Space Technique is presented.

- c) General Method of Estimation for the assessment of % Carbon, % Nitrogen, % Hydrogen and % Sulfur is also presented. Analysis of % Sulfur by this method can be directly applied to the analysis of Sulfur; Class D1 of Schedule -2. Further, this method may be used as a screening technique for the analysis of Organic Sulfur Compounds; Class C10, Mercaptans; Class B20, Organic Oxygen Compounds; Class D6 and Organic Nitrogen Compounds; Class D7 of Schedule -2.

For the analysis of organic parameters, the physical conditions of the sample (as they are at the time of sample collection) must not be changed. Hence, it is suggested that the samples for organic analysis should not be air dried or oven dried and analysis must be performed on 'sample-as-is-where-is' basis. However, the analytical results must be reported on the basis of dry weight of the sample, if the sample is sludge, slurry or a solid waste.

At times, the samples could be liquids, which are essentially non-aqueous in nature with or without some trace amounts of water in the waste. In such cases, estimate the moisture content in the waste sample by Karl Fischer Method (as described in Chapter 4) and report the results either mg/L or mg/kg of waste.

Hereinafter, sample for analysis means that the sample taken on as-is-where-is basis

## **6.4 SAMPLE PREPARATION METHOD FOR ORGANIC ANALYSIS - SOXHLET EXTRACTION**

### **6.4.1 Scope and Application**

- i) This procedure is for extracting nonvolatile and semi volatile organic compounds from solids such as soils, sludges, and wastes. The soxhlet extraction process ensures intimate contact of the sample matrix with the extraction solvent.
- ii) This method is applicable to the isolation and concentration of water-insoluble and lightly water-soluble organic compounds in preparation for a variety of chromatographic procedures.

### **6.4.2 Principle**

Soxhlet extraction technique enables extraction of total recoverable organic analytes on the basis of solubility and difference in boiling points in to a minimum volume of selected solvent.

### **6.4.3 Summary of the Method**

The solid sample is mixed with anhydrous sodium sulfate, placed in an extraction thimble or between two plugs of glass wool, and extracted using an appropriate solvent in a soxhlet extractor. The extract is then dried,

concentrated, and, as necessary, exchanged in to a solvent compatible with the cleanup or determinative step being employed

#### 6.4.4 Interferences

- i) Solvents, reagents glassware, and other sample processing hardware may yield artifacts and/or interferences to sample analysis. All these materials must be demonstrated to be free from interferences under the conditions of the analysis by analyzing method blanks.
- ii) Specific selection of reagents and purification of solvents by distillation in all glass systems may be required. If analysis of an extracted sample is prevented due to interferences, further cleanup of the sample extract may be necessary.
- iii) Phthalate esters contaminate many types of products commonly found in the laboratory. Plastics in particular must be avoided because phthalates are commonly used as plasticizers and are easily extracted from plastic materials. Serious phthalate contamination may result at any time if consistent quality control is not practiced.
- iv) Glassware contamination resulting in analyte degradation: soap residue on glassware may cause degradation of certain analytes. Specifically aldrin, heptachlor, and most organophosphorous pesticides will degrade in this situation. This problem is especially pronounced with glassware that may be difficult to rinse (e.g., 500 mL K-D flask). These items should be hand rinsed very carefully to avoid this problem

#### 6.4.5 Apparatus and Materials

- i) Soxhlet extractor: 40 mm I.D., with 500 mL round-bottom flask. (Fig-6.1)
- ii) Drying column: 20 mm-I.D., with Pyrex chromatographic column with Pyrex glass wool at bottom and a Teflon stopcock.
- iii) Kuderna Danish (K-D) apparatus: 10-mL graduated or equivalent). Ground glass stopper is used to prevent evaporation of extracts. (Fig-6.2)
- iv) Evaporation flask: 500 mL; Attached to concentrator tube with springs.
- v) Snyder column: Three-ball macro column
- vi) Snyder column: Two- ball micro column.

- vii) Boiling chips: Solvent extracted, approximately 10/40 mesh (silicon carbide or equivalent).
- viii) Water bath: Heated, with concentric ring cover, capable of temperature control  $\pm 5^{\circ}\text{C}$ . The bath should be used in a hood.
- ix) Vials: glass, 2 mL capacity with Teflon line screw cap.
- x) Glass fibre or paper thimble or glass wool: contaminant free.
- xi) Heating mantle: Rheostat controlled.
- xii) Syringe: 5 mL
- xiii) Apparatus for determining percent moisture:
- xiv) Oven: Drying.
- xv) Desiccator.
- xvi) Crucibles: porcelain.
- xvii) Apparatus for grinding: If the sample will not pass through a 1-mm standard sieve or cannot be extruded through a 1- mm opening, it should be processed into a homogeneous sample that meets these requirements. This grinder should handle most solid samples, except gummy, fibrous, or oily materials

#### 6.4.6 Reagents

- i) Reagent water: is defined as water in which interference is not observed at the method detection limit of the compounds of interest.
- ii) Sodium sulfate: Americal Chemical Society (ACS) granular anhydrous (purified by washing with methylene chloride followed by heating at  $400^{\circ}\text{C}$ .for 4 hours in a shallow tray.)
- iii) Extraction solvents: Soil/sediment and aqueous sludge samples shall b extracted using either of the following solvents.
- iv) Toluene & Methanol: 10:1 (v/v), pesticide quality or equivalent.
- v) Acetone & Hexane: 1:1 (v/v), pesticide quality or equivalent.
- vi) Other samples shall be extracted using the following:
- vii) Methylene chloride: pesticide quality or equivalent.
- viii) Exchange solvents: Hexane, 2 propanol, cyclohexane, acetonitrile (pesticide quality or equivalent).

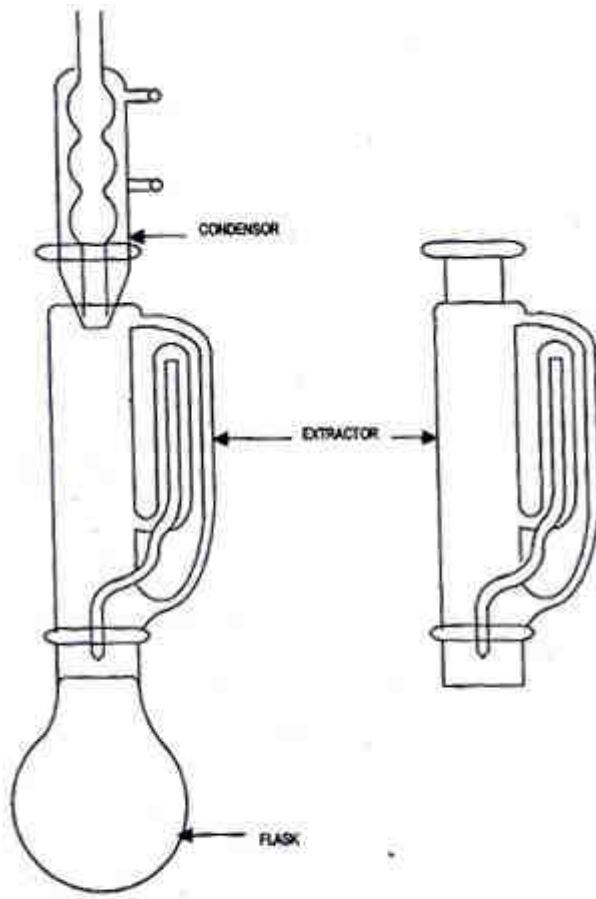

Fig. 6.1 Soxhlet Extraction Apparatus

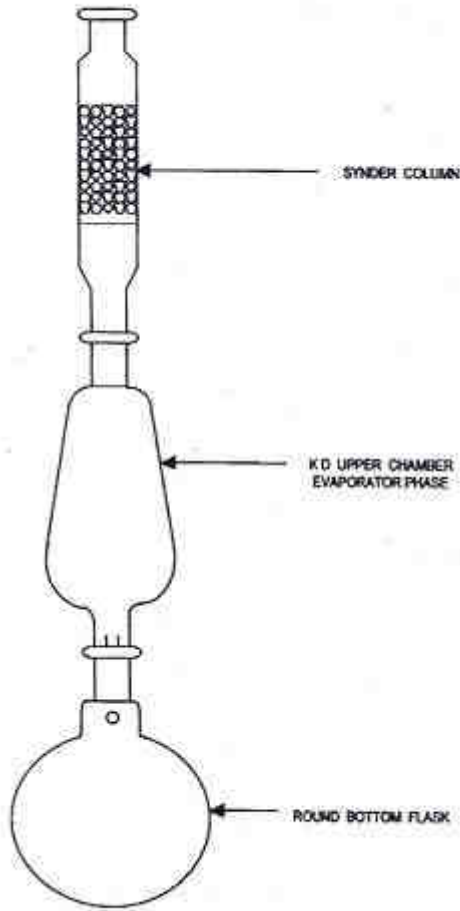

Fig. 6.2 Kuderna Danish Evaporator

#### 6.4.7 Sample Preparation Method

- i) Sediment/soil samples: Decant and discard any water layer on a sediment sample. Mix sample thoroughly, especially composited samples. Discard any foreign objects such as ticks, leaves, and rocks.
- ii) Waste samples: Samples consisting of multiphase must be prepared by the phase separation method before extraction.
- iii) Dry waste samples amenable to grinding: Grind or otherwise subdivide the waste so that it either passes through a 1-mm sieve or can be extruded through a 1-mm hole. Introduce sufficient sample into the grinding apparatus to yield at least 10 g after grinding

#### 6.4.8 Analytical Procedure

- i) Determination of percent moisture
- ii) In certain cases, sample results are desired based on a dry weight basis. Weigh 5-10 g of the sample into a tarred crucible. Determine the percent moisture by drying overnight at 105<sup>0</sup>c. Allow cooling in a desiccator before weighing of sample-g of dry sample/g of sample x 100 = % moisture.
- iii) Blend 10 g of the solid sample with 10 g of anhydrous sodium sulfate and place in the extraction thimble. The extraction thimble must be drain freely for the duration of the extraction period. A glass wool plug above and below the sample in the soxhlet extractor is an acceptable alternative for the thimble.
- iv) Add 1.0 mL of surrogate standard spiking solution on to the samples as suggested in analytical methods. Place 300 mL of the extraction solvent into a 500-mL round bottom flask containing one or two clean boiling chips. Attach the flask to the extractor and extract the sample for 16 to 24 hrs.
- v) Allow the extract to cool after the extraction is complete.
- vi) Assemble a Kuderna-Danish (K-D) concentrator by attaching a 10 -mL concentrator tube to a 500–mL evaporation flask.
- vii) Dry the extract by passing it through a drying column containing about 10 cm of anhydrous sodium sulfate. Collect the dried extract in a K-D concentrator. Wash the extractor flask and sodium sulfate column with 100-125 mL of extraction solvent to complete the quantitative transfer.

- viii) Add one or two clean boiling chips to the flask and attach a three – ball Snyder column. Pre wet the Snyder column by adding about 1 mL of methylene chloride to the top of the column.
- ix) Place the K-D apparatus on a hot water bath (15 to 20<sup>0</sup>c. above the boiling point of the solvent) so that the concentrator tube is partially immersed in the hot water and the entire lower rounded surface of the flask is bathed with hot vapor.
- x) Adjust the water temperature, as required to complete the concentration in 10-20 min. When the apparent volume of liquid reaches 1 mL, remove the K-D apparatus from the water bath and allow draining and cooling for at least 10 min.
- xi) If a solvent exchange is required (as indicated in table 6.1), momentarily remove the Snyder column, add 50 mL of the exchange solvent and a new boiling chip, and re attach the Snyder column. Concentrate the extract by raising the temperature of the water bath, if necessary, to maintain proper distillation.
- xii) Remove the Snyder column and rinse the flask and its lower joints into the concentrator tube with 1-2 mL of methylene chloride or exchange solvent. If sulfur crystals are a problem, proceed to sulfur clean up.
- xiii) If further concentration is required as indicated in table 6.1 add another one or two clean boiling chips to the concentrator tube and attach a two- ball micro Snyder column
- xiv) Pre wet the column by adding 0.5 mL of methylene chloride or exchange solvent to the top of the column. Place the K-D apparatus in a hot water bath so that the concentrator tube is partially immersed in the hot water.
- xv) Adjust the vertical position of the apparatus and the water temperature as required, to complete the concentration in 5-10 min. When the apparent volume of liquid reaches 0.5 mL, remove the K-D apparatus from the water bath and allow it to drain and cool at least for 10 min. Remove the Snyder column and rinse the flask and its lower joints into the concentrator tube with 0.2 mL of solvent. Adjust the final volume to 1.0 –2.0 mL, as indicated in table- 6.1, with solvent.
- xvi) The extracts obtained may now be analyzed for analyte content using a G.C or other techniques. If analysis of the extract will not be performed immediately, stopper the concentrator tube and store refrigerated. If the extract will be stored longer than 2 days, it should be transferred to a Teflon-sealed screw-cap vial and labeled appropriately.



## 6.4.9 Calculations

Measure the final volume of the extract and record.

## 6.4.10 Quality Control

- i) Any reagent blanks or matrix spike samples should be subjected to exactly the same analytical procedures as those used on actual samples.
- ii) Before processing any samples, the analyst should demonstrate through the analysis of reagent water blank that all glassware and reagents are interference free. Each time a set of samples is processed, a method blank (s) should be processed as a safeguard against chronic laboratory contamination.
- iii) The blank samples should be carried through all stages of the sample preparation and measurement.
- iv) Surrogate standards should be added to all samples when specified in the appropriate determination methods.
- v) A reagent blank, a matrix spike, and a duplicate or matrix spike duplicate must be performed for each analytical batch up to a maximum of 20 samples analyzed.
- vi) For GC analysis, the analytical system performance must be verified by analyzing quality control (QC) check samples, which must be handled in exactly the same manner as actual
- vii) samples. Therefore, 1.0 mL of the QC check sample concentrate is spiked into each of four 1-L aliquots of reagent water, extracted and then analyzed by GC. The concentration of the QC check sample concentrate for the various methods are as follows:
- viii) Organochlorine pesticides and PCBs: The QC Check sample concentrate should contain each single-component analyte at the following concentrations in acetone: 4,4'-DDD, 10 µg/mL; 4,4'-DDT, 10 µg/mL; endosulfan II, 10 µg/mL; endosulfan sulfate, 10 µg/mL; and any other single-component pesticide at 2 µg/mL. If the method is only to be used to analyze PCBs, chlordane, or toxaphene, the QC check sample concentrate should contain the most representative multicomponent parameter at a concentration of 50 µg/mL in acetone.
- ix) Polynuclear aromatic hydrocarbons: The QC check sample concentrate should contain each analyte at the following concentrations in acetonitrile: naphthalene, 100 µg/mL;

- x) acenaphthylene, 100 µg/mL; acenaphthene, 100ug/mL; fluorene, 100ug/mL; phenanthrene, 100ug/mL; anthracene, 100 ug/mL; benzo (k) fluoranthene 5 ug/mL; and any other PAH at 10ug/mL.
- xi) Chlorinated hydrocarbons: The QC check sample concentrate should contain each analyte at the following concentrations in acetone: hexachloro-substituted hydrocarbons, 10 ug/mL; and any other chlorinated hydrocarbon 100 ug/mL

**Table 6.1**

**Specific Extraction Conditions for Various Determinative Methods**

Determinative method	Extraction pH	Exchange solvent required for analysis	Exchange solvent required for Cleanup	Volume of extract required for cleanup (mL)	Final extract volume for analysis (mL)
1. Organochlorine pesticides and PCBs	As received	Hexane	hexane	10.0	10.0
2. Polynuclear Aromatic Hydrocarbons	As received	None	Cyclohexane	2.0	1.0
3. Chlorinated hydrocarbons	As received	Hexane	Hexane	2.0	1.0

**6.4.11 References**

1. Test Methods for Evaluating Solid Wastes, Method 3540C, SW-846, USEPA, 1996 and updates

**6.5 SAMPLE CLEAN UP PROCEDURE FOR ORGANIC ANALYTES - SILICA GEL CLEAN-UP METHOD**

**6.5.1 Scope And Application**

- i) Silica gel (silicic acid) is a regenerative adsorbent of silica with weakly acidic properties. It is produced from sodium silicate and sulfuric acid. Silica gel can be used in the column chromatography for the separation of analytes from interfering compounds of a different chemical polarity. It may be used activated, after heating to 150-160<sup>0</sup>c, or deactivated with up to 10% water.
- ii) This method includes guidance for standard column clean up of sample extracts containing polynuclear aromatic hydrocarbons, organochlorine pesticides, and PCBs as Aroclors.

- iii) This method is restricted to use by or under the supervision of trained analysts. Each analyst must demonstrate the ability to generate acceptable results with this method.

### **6.5.2 Summary of the Method**

- i) This method provides the option of using either standard column chromatography techniques.
- ii) In the standard column clean up protocol, the column is packed with the required amount of adsorbent, topped with a water adsorbent, and then loaded with the sample to be analyzed.
- iii) Elution of the analytes is accomplished with a suitable solvents(s) that leaves interfering compounds on the column. The eluate is then concentrated (if necessary).

### **6.5.3 Interferences**

- i) Solvents, reagents, glassware, and other sample processing hardware may yield discrete artifacts and/or elevated baselines causing misinterpretation of gas chromatograms.
- ii) Phthalate ester contamination may be a problem with certain cartridges.

### **6.5.4 Apparatus and Materials**

- i) Chromatographic column-250 mm long x10 mm ID; with Pyrex glass wool at bottom and a PTFE stopcock.
- ii) Beakers-appropriate sizes.
- iii) Vials-2, 10, 25 mL, glass with PTFE-lined screw caps or crimp tops.
- iv) Muffle furnace
- v) Reagent bottle-appropriate sizes.
- vi) Erlenmeyer flasks-50 and 250 mL.

### **6.5.5 Reagents**

- i) Chromatographic column-250 mm long \*10 mm ID; with Pyrex glass wool at bottom and a PTFE stopcock.
- ii) Beakers-appropriate sizes.

- iii) Vials-2, 10, 25 mL, glass with PTFE-lined screw caps or crimp tops.
- iv) Muffle furnace
- v) Reagent bottle-appropriate sizes.
- Vi) Erlenmeyer flasks-50 and 250 mL.
- vii) Cyclohexane, C<sub>6</sub>H<sub>12</sub>- pesticide quality or equivalent.
- viii) Hexane, C<sub>6</sub>H<sub>14</sub> – Pesticide quality or equivalent.
- ix) 2-Propanol, (CH<sub>3</sub>)<sub>2</sub>CHOH-Pesticide quality or equivalent.
- x) Toluene, C<sub>6</sub>H<sub>5</sub>CH<sub>3</sub>-Pesticide quality or equivalent.
- xi) Methylene chloride, CH<sub>2</sub>Cl<sub>2</sub>-Pesticide quality or equivalent.
- xii) Pentane, C<sub>5</sub>H<sub>12</sub>-Pesticide quality or equivalent.
- xiii) Acetone, CH<sub>3</sub>COCH<sub>3</sub>-Pesticide quality or equivalent.
- xiv) Diethyl ether, C<sub>2</sub>H<sub>5</sub>OC<sub>2</sub>H<sub>5</sub>. Pesticide quality or equivalent. Must be free of peroxides are provided with the test strips. After cleanup, 20 mL of ethanol preservatives must be added to each liter of ether.

#### 6.5.6 Sample Preparation Method

- a) **Standard column Cleanup Techniques for Polynuclear aromatic hydrocarbons:**
  - i) Prepare slurry of 10 g of activated silica gel in methylene chloride and place this into a 10 mm ID chromatographic column. Tap the column to settle the silica gel and elute the methylene chloride. Add 1 to 2 cm of anhydrous sodium sulfate to the top of the silica gel.
  - ii) Pre elute the column with 40 mL of pentane. The rate of all elutions should be about 2 mL/min. Discard the eluate and, just prior to exposure of the sodium sulfate layer to the air, transfer the 2 mL cyclohexane sample extract on to the column using an additional 2 mL cyclohexane to complete the transfer. Just prior to exposure of the sodium sulfate layer to the air, add 25 mL of pentane and continue the elution of the column. Discard this pentane eluate.

- iii) Next, elute the column with 25 mL of methylene chloride/pentane (2:3)(v/v) into a flask for concentration. Concentrate the collected fraction to whatever volume is required (1-10mL). Proceed with GC analysis. Validated components that elute in this fraction are:

Acenaphthene	Chrysene
Acenaphthylene	Dibenzo (a, h) anthracene
Anthracene	Flouranthene
Benzo(a)anthracene	Flourene
Benzo(a)pyrene	Indeno(1,2,3-cd) pyrene
Benzo(b)flouranthene	Naphthalene
Benzo(g,h,i perylene)	Phenanthrene
Benzo(k)flouranthene	Pyrene

b) **Standard column Cleanup Techniques Organochlorine Pesticides and PCBs:**

- i) Transfer a 3 g portion of deactivated silica gel into a 10 mm ID glass chromatographic column and top it with 2 to 3 cm of anhydrous sodium sulfate.
- ii) Add 10 mL of hexane to the top of the column to wet and rinse the sodium sulfate and silica gel. Just prior to exposure of the sodium sulfate layer to air, stop the hexane eluate flow by closing the stopcock on the chromatographic column. Discard the eluate.
- ii) Transfer the sample extract (2 mL in hexane) on to the column. Rinse the extract vial twice with 1 to 2 mL of hexane and add each rinse to the column. Elute the column with 80 mL of hexane (Fraction-1) at a rate of about 5 mL/min. Remove the collection flask and set it a side for later concentration. Elute the column with 50 mL of hexane (fraction-2) and collect the eluate. Perform a third elution with 15 mL of methylene chloride (fraction-Prior to gas chromatographic analysis, the extraction solvent must be exchanged to hexane. Fractions may be combined as desired, depending upon the specific pesticides/PCBs of interest or level of interferences. Analyze fraction-1 containing PCBs separated from most pesticides by suitable analytical method.

### 6.5.7 Quality Control

- i) A reagent blank must be processed through the column or cartridge and checked for the compounds of interest, prior to the use of this

method. The level of interferences must be below the method detection limit before this method is performed on actual samples.

- ii) The analyst must demonstrate that the compounds of interest are being quantitatively recovered before applying this method to actual samples.
- iii) For sample extracts that are cleaned up using this method, the associated quality control samples should also be processed through this cleanup method

### **6.5.8 References**

1. Test Methods for Evaluating Solid Wastes, SW-846, 1996 and Updates.

## **6.6 ANALYTICAL PROCEDURE FOR POLYNUCLEAR AROMATIC HYDROCARBON**

### **6.6.1 Scope And Application**

- i) This is used to determine the concentration of certain polynuclear aromatic hydrocarbons (PAH).
- ii) The packed column gas chromatographic method described here cannot adequately resolve the following four parts of compounds: anthracene and phenanthrene: chrysene and benzo(a) anthracene; benzo (b) fluoranthene and benzo (k) fluoranthene; and dibenzo (a, h) anthracene and indeno (1,2,3-cd) pyrene. The use of a capillary column instead of the packed column, also described in this method, may adequately resolve these PAHs.

### **6.6.2 Principle**

Principle of the method involves separation of different PAH compounds in the sample by Chromatographic Technique and detection and quantification by Flame Ionization Detector.

### **6.6.3 Summary of the Method**

- i) This method provides gas chromatographic conditions for the detection of ppb levels of certain polynuclear aromatic hydrocarbons. Prior to use to this method, appropriate sample extraction techniques must be used.
- ii) 2- to 5-mL aliquot of the extract is injected into a gas chromatograph (GC) using the solvent flush technique, and compounds in the GC effluent are detected by a flame ionization detector (FID).

- iii) If interferences prevent proper detection of the analytes of interest, the method may also be performed on extracts that have undergone cleanup using silica gel column cleanup.

#### **6.6.4 Interferences**

- i) Refer to sample preparation/extraction, cleanup methods.
- ii) Solvents, reagents, glassware and other sample processing hardware may yield discrete artifacts and or elevated baselines causing misinterpretation of gas chromatograms. All of these materials must be demonstrated to be free from interferences, under the conditions of the analysis, by analyzing method blanks. Specific selection of reagents and purification of solvents by distillation in all-glass systems may be required
- iii) Interferences co extracted from samples will vary considerably from source to source, depending upon the waste being sampled. Although general cleanup techniques are recommended as part of this method, unique samples may require additional cleanup.

#### **6.6.5 Apparatus and Materials**

- i) Gas chromatograph: Analytical system complete with gas chromatograph suitable for on-column injections and all required accessories, including detectors, column supplies, recorder, gases and syringes. A data system for measuring peak areas and or peak heights is recommended.
- ii) Columns:
- iii) Column 1: 1.8 m x 2 mm I.D. glass column packed with 3% OV-17 on Chromosorb W-AW-DCMS (100/120 mesh) or equivalent.
- iv) Column 2: 30-m x 0.25-mm I.D. SE-54 fused silica capillary column.
- v) Column 3: 30-m x 0.32 I.D. SE-54 fused silica capillary column.
- vi) Detector: Flame ionization (FID).
- vii) Volumetric flask: 10-, 50- and 100-mL, ground glass stopper.
- viii) Micro syringe: 10 $\mu$ l

#### **6.6.6 Reagents**

- i) Solvents: Hexane, isooctane (2,2,4-trimethylpentane) (pesticide quality or equivalent).

- ii) Stock standard solutions: Prepare stock standard solutions at a concentration of 1.00 µg/µL by dissolving 0.01g of assayed reference material in isooctane and diluting to volume in a 10 mL volumetric flask. Larger volumes can be used at the convenience of the analyst. When compound purity is assayed to be 96% or greater, the weight can be used without correction to calculate the concentration of the stock standard. Commercially prepared stock standards can be used at any concentration if they are certified by the manufacturer or by an independent source.
- iii) Transfer the stock standard solutions into Teflon-sealed screw cap bottles. Store at 4°C and protect from light. Stock standards should be checked frequently for signs of degradation or evaporation, especially just prior to preparing calibration standards from them.
- iv) Stock standard solutions must be replaced after one year, or sooner if comparison with check standards indicate a problem.
- v) **Calibration standards:** Calibration standards at a minimum of five concentration levels should be prepared through dilution of the stock standards with isooctane. One of the concentration levels should be at a concentration near, but above, the method detection limit. The remaining concentration levels should correspond to the expected range of concentrations found in real samples or should define the working range of the GC. Calibration solutions must be replaced after six months or sooner if comparison with a check standard indicates a problem.
- vi) **Internal standards** (if internal standard calibration is used): To use this approach, the analyst must select one or more internal standards that are similar in analytical behavior to the compounds of interest. The analyst must further demonstrate that the measurement of the internal standard is not affected by method or matrix interferences. Because of these limitations, no internal standard can be suggested that is applicable to all samples.
- vii) Prepare calibration standards at a minimum of five concentration levels for each analyte of interest.
- viii) To each calibration standard, add a known constant amount of one or more internal standards, and dilute to volume with isooctane.
- ix) Analyze each calibration standard.
- x) Surrogate standards: The analyst should monitor the performance of the extraction, cleanup (when used), and analytical system and the effectiveness of the method in dealing with each sample matrix by



spiking each sample, standard, and reagent water blank with one or two surrogates (e.g., 2-fluorobiphenyl and 1-fluoronaphthalene) recommended to encompass the range of the temperature program used in this method.

#### 6.6.7 Sample Preparation Method

- i) Extraction: see the soxhlet extraction procedure.
- ii) Gas chromatography conditions (Recommended):
- iii) Column 1: Set nitrogen carrier gas flow at 40 mL/min flow rate. Set column temperature at 100<sup>0</sup>C for 4 min; then program at 8<sup>0</sup>C/min to a final hold at 280<sup>0</sup>C
- iv) Column 2: Set helium carrier gas at 20-cm/sec-flow rate. Set column temperature at 35<sup>0</sup>C for 2min; then program at 10<sup>0</sup>C/min to 265<sup>0</sup>C and hold for 12 min.
- v) Column 3: set helium carrier gas at 60-cm/se-flow rate. Set column temperature at 35<sup>0</sup>C for 2 min; then program at 10<sup>0</sup>C/min to 265<sup>0</sup>C and hold for 3 min.
- vi) If cleanup is performed on the samples, the analyst should process a series of standards through the cleanup procedure and then analyze the samples by GC. This will validate elution patterns and the absence of interferents from the reagent.

#### 6.6.8 Analytical Procedure

##### Gas chromatographic analysis:

- i) If the internal standard calibration technique is used, add 10 µL of internal standard to the sample prior to injection.
- ii) Record the sample volume injected and the resulting peak sizes (in area units or peak heights). Using either the internal or external calibration procedure, determine the identity and quantity of each component peak in the sample chromatogram, which corresponds to the compounds used for calibration purposes.
- iii) If peak detection and identification are prevented due to interferences, the extract may undergo cleanup.
- iv) Cleanup: see cleanup procedure above

### **6.6.9 Quality Control**

- i) A reagent blank must be processed through the column or cartridge and checked for the compounds of interest, prior to the use of this method. The level of interferences must be below the method detection limit before this method is performed on actual samples.
- ii) The analyst must demonstrate that the compounds of interest are being quantitatively recovered before applying this method to actual samples.
- iii) For sample extracts that are cleaned up using this method, the associated quality control samples should also be processed through this cleanup method
- iv) Recalculate the data and or reanalyze the extract if any of the above checks reveal a problem. Re-extract and reanalyze the sample if none of the above are problems or flag the data as "estimated concentration."

### **6.6.10 References**

1. Test Methods for Evaluating Solid Wastes, SW-846, USEPA, 1996 and updates.

## **6.7 ORGANOCHLORINE PESTICIDES AND PCBS**

### **6.7.1 Scope and Application**

This method is used to determine the concentration of various organochlorine pesticides and polychlorinated biphenyls (PCBs). Table 6.2 indicates compounds that may be determined by this method and lists the method detection limit for each compound in reagent water.

### **6.7.2 Principle**

Principle of the method involves separation of different PAH compounds in the sample by Chromatographic Technique and detection and quantification by Electron Capture Detector (ECD)

### **6.7.3 Summary Of The Method**

- i) This method provides gas chromatographic conditions for the detection of ppb levels of certain organochlorine pesticides and PCBs. Prior to the use of this method, appropriate sample extraction techniques must be used. A 2- to 5- uL sample is injected into a gas chromatograph (GC) using the solvent flush technique, and compounds in the GC

effluent are detected by an electron capture detector (ECD) or a halogen-specific detector (HSD).

- ii) The sensitivity of method usually depends on the level of interferences rather than on instrumental limitations. If interferences prevent detection of the analytes, this method may also be performed on samples that have undergone cleanup. Florisil column cleanup, by itself or followed by sulfur cleanup may be used to eliminate interferences in the analysis.

#### 6.7.4 Interferences

- i) Refer earlier methods of sample preparation, cleanup methods.
- ii) Interferences by phthalate esters can pose a major problem in pesticide determinations when using the electron capture detector. These compounds generally appear in the chromatogram as large late-eluting peaks, especially in the 15% and 50% fraction from the Florisil cleanup. Common easily extracted or leached from such materials during laboratory operation. Cross contamination of clean glassware routinely occurs when plastics are handled. Interferences from phthalates can best be minimized by avoiding contact with any plastic materials. Exhaustive cleanup of reagents and glassware may be required to eliminate background Phthalate contamination. The contamination from phthalate esters can be completely eliminated with a microcoulometric or electrolytic conductivity detector

**Table 6.2**  
**Gas Chromatography of Pesticides and PCBs**

Compound	Retention Time (min)		Method Detection Limit (ug/L)
	Col.1	Col.2	
Aldrin	2.40	4.10	0.004
$\alpha$ -BHC	1.35	1.82	0.003
$\beta$ -BHC	1.90	1.97	0.006
$\gamma$ -BHC (Lindane)	2.15	2.20	0.009
$\delta$ -BHC (Lindane)	1.70	2.13	0.004
Chlordane (technical)	e	e	0.014
4,4'-DDD	7.83	9.08	0.011
4,4'-DDE	5.13	7.15	0.004
4,4'-DDT	9.40	11.75	0.012
Dieldrin	5.45	7.23	0.002
Endosulfan I	4.50	6.20	0.014
Endosulfan II	8.00	8.28	0.004
Endosulfan sulfate	14.22	10.70	0.066
Endrin	6.55	8.10	0.006

Endrin aldehyde	11.82	9.30	0.023
Heptachlor	2.00	3.35	0.003
Heptachlor epoxide	3.50	5.00	0.083
Methoxychlor	18.20	26.60	0.176
Toxaphene	e	e	0.24
PCB-1016	e	e	Nd
PCB-1221	e	e	Nd
PCB-1232	e	e	Nd
PCB-1242	e	e	0.065
PCB-1248	e	e	Nd
PCB-1254	e	e	Nd
PCB-1260	e	e	Nd

- DDE - Dichloro dimethyl ethion  
 BHC - benzene Hexa Chloride  
 DDE - 1,1 prime – (2,2 – dichloroethylethane) bis (4 - chlorobenzene)  
 DDD(TDE) - 1,1 prime – (2-2 dichloroethylidene)  
 DDT - Dichloro Diethyl Trichloroethylene

USEPA method 617. Organo chloride pesticides and PCBs. Environmental Monitoring and Support Laboratory, Cincinnati, Ohio 45268

e = Multiple peak response

Nd = not determined

### 6.7.5 Apparatus and Materials

#### a) Gas Chromatograph:

Gas chromatograph: Analytical system complete with gas chromatograph suitable for on-column injections and all required accessories, including detectors, column supplies, recorder, gasses, and syringes. A data system for measuring peak heights and or peak areas is recommended.

#### b) Columns:

- i) Column 1: Supelco port (100/120 mesh) coated with 1.5% SP-2250/1.95% SP-2401 packed in a 1.8 m x 4mm I.D. glass column or equivalent.
- ii) Column 2: Supelco port (100/120 mesh) coated with 3% OV-1 in a 1.8 m x 4 mm I.D. glass column or equivalent.
- iii) Detectors: Electron capture (ECD) or halogen specific (HSD) (i.e., electrolytic ). conductivity detector

### 6.7.6 Reagents

- i) Solvents: Hexane, acetone, toluene, isooctane (2,2,4-trimethyl pentane) (pesticide quality or equivalent).
- ii) Stock standard solutions: Prepare stock standard solutions at a concentration of 1.00 ug/uL by dissolving 0.0100 g of assayed reference material in isooctane and diluting to volume in a 10 mL volumetric flask. A small volume of toluene may be necessary to put some pesticides in solution. Larger volumes can be used at the convenience of the analyst. When compound purity is assayed to be 96% or greater, the weight can be used without correction to calculate the concentration of the stock standard. Commercially prepared.
- iii) stock standards can be used at any concentration if they are certified by the manufacturer or by an independent source.
- iv) Transfer the stock standard solutions into Teflon-sealed screw-cap bottles. Store at 4<sup>0</sup>C and protect from light. Stock standards should be checked frequently for signs of degradation or evaporation, especially just prior to preparing calibration standards from them. Stock standard solutions must be replaced after one year, or sooner if comparison with checks standards indicate a problem
- v) Calibration standards: Calibration standards at a minimum of five concentration levels for each parameter of interest are prepared through concentration levels for each parameter of interest are prepared through dilution of the stock standards with isooctane. One of the concentration levels should be at a concentration near, but above, the method detection limit. The remaining concentration levels should correspond to the expected range of concentrations found in real samples or should define the working range of the GC. Calibration solutions must be replaced after six months, or sooner, if comparison with checks standards indicates a problem.
- vi) Internal standards (if internal standard calibration is used): To use this approach, the analyst must select one or more internal standards that are similar in analytical behavior to the compounds of interest. The analyst must further demonstrate that the measurement of the internal standard is not affected by method or matrix interference. Because of this limitation, no internal standard can be suggested that is applicable to all samples.
- vii) Prepare calibration standards at a minimum of five concentration levels for each analyte of interest as described in earlier paragraphs.

- viii) To each calibration standard, add a known constant amount of one or more internal standards, and dilute to volume with isooctane.
- ix) Analyze each calibration standard.
- x) Surrogate standards: The analyst should monitor the performance of the extraction, cleanup (when used), and analytical system and the effectiveness of the method in dealing with each sample matrix by spiking each sample, standard, and reagent water blank with pesticide surrogates. Because GC/ECD data are much more subject to interference than GC/MS, a secondary surrogate is to be used when sample interference is apparent. Dibutyl chlorodate (DBC) is also subject to acid and base degradation. Therefore, two surrogate standards are added to each sample; however, only one need be calculated for recovery. DBC is the primary surrogate and should be used whenever possible. However, if DBC recovery is low or compounds interfere with DBC, then the 2,4,5,6-tetrachloro-metaxylene should be evaluated for acceptance. Proceed with corrective action when both surrogates are out of limits for a sample.

#### **6.7.7 Sample Preparation Method**

- i) Extraction: follow soxhlet extraction method.
- ii) Gas chromatography conditions (Recommended)
- iii) Column 1: Set 5% methane / 95% argon carrier gas flow at 60 mL/min flow rate. Column temperature is set at 200<sup>0</sup>C isothermal. When analyzing for the low molecular weight PCBs (PCB 1221-PCB 1248), it is advisable to set the oven temperature to 160<sup>0</sup>C.
- iv) Column 1: Set 5% methane / 95% argon carrier gas flow at 60 mL/min flow rate. Column temperature held isothermal at 200<sup>0</sup>C. When analyzing for the molecular weight PCBs (PCB 1221-PCB 1248), it is advisable to set the oven temperature to 140<sup>0</sup>C. When analyzing for most or all of the analytes in this method, adjust the oven temperature and column gas flow so that 4,4'-DDT has a retention time of approximately 12 min.
- v) Calibration: Establish gas chromatographic operating parameters. Calibrate the chromatographic system using either the external standard technique or the internal standard technique.
- vi) External standard calibration procedure: For each analyte of interest, prepare calibration standards at a minimum of five concentration levels by adding one or more standards to a volumetric flask and diluting to volume with an appropriate solvent. One of the external standards

should be at a concentration near, but above, the method detection limit. The other concentrations should correspond to the expected range of concentrations found in real samples or should define the working range of the detector.

- vii) Inject each calibration standard using the technique that will be used to introduce the actual samples into the gas chromatograph (e.g., 2- to 5- ul injections, purge and trap, etc.). Tabulate peak height or area responses against the mass injected. The results can be used to prepare a calibration curve for each analyte. Alternatively, for samples that are introduced into the gas chromatograph using a syringe, the ratio of the response to the amount injected, defined as the calibration factor (CF), can be calculated for each analyte at each standard concentration. If the percent relative standard deviation (%RSD) of the calibration factor is less than 20% over the working range, linearity through the origin can be assumed, and the average calibration factor can be used in place of calibration curve.
- viii) Calibration factor = Total area of peak / mass injected in nanograms. For multi response pesticides/PCBs use the total area of all peaks used for quantification.
- ix) The working calibration curve or calibration factor must be verified on each working day by the injection of one or more calibration standards. The frequency of verification is dependent on the detector. Detectors such as electron capture detector, which operate in the sub- nanogram range, are more susceptible to changes in detector response caused by GC column and sample effects. Therefore very frequent verification of calibration is necessary. The flame ionization detector is much less sensitive and requires less frequent verification. If the response for any analyte varies from the predicted response by more than + or – 15% new calibration curve must be prepared for that analyte.

$$\text{Percent difference} = \frac{R1 - R2}{R1} \times 100$$

Where:

R1= calibration factor from first analysis.

R2=calibration factor from succeeding analysis

- x) Because of the low concentration of pesticide standards injected on a GC/ECD, column adsorption maybe a problem when the GC has not been used for a day. Therefore, then GC column should be primed or deactivated by injecting a PCB or pesticide standard mixture approximately 20 times more concentrated than the mid-level standard. Inject this prior to beginning initial or daily calibration.

## 6.7.8 Analytical Procedure

### Gas chromatographic analysis:

- i) Include a mid-level standard after each group of 10 samples in the analysis sequence.
- ii) DDT and endrin are easily degraded in the injection port if the injection port or front of the column is dirty. This is the result of buildup of high boiling residue from sample injection. Check for degradation problems by injecting a mid-level standard containing only 4,4'-DDT and 4,4'-DDT. Look for the degradation products of 4,4'-DDT (4,4'-DDE and 4,4'-DDD) and endrin (endrin ketone and endrin aldehyde). If degradation of either DDT or endrin exceeds 20% take corrective action before proceeding with calibration, by following the GC system maintenance. Calculated percent breakdown as follows:

$$\% \text{ Break down for } 4,4'\text{-DDT} = \frac{\text{Total DDT degradation peak area (DDE + DDD)}}{\text{Total DDT peak area (DDT + DDE + DDD)}} \times 100$$

$$\% \text{ Break down for Endrin} = \frac{\text{Total endrin degradation peak area (endrin aldehyde + endrin ketone)}}{\text{Total endrin peak area (endrin + endrin aldehyde + endrin ketone)}} \times 100$$

- iii) Record the sample volume injected and the resulting peak sizes (in area units or peak heights).
- iv) Using either the internal or external calibration procedure determine the identity and quantity of each component peak in the sample chromatogram, which corresponds to the compounds used for calibration purposes.
- v) If peak detection and identification are prevented due to interferences, the hexane extract may need to undergo cleanup. The resultant extract (s) maybe analyzed by GC directly or may undergo further cleanup to remove sulfur using method sulfur cleanup

### Cleanup

- i) Proceed with method Florisil column cleanup followed by, if necessary, method sulfur cleanup, using the 10 mL hexane extract.
- ii) Following cleanup, GC should analyze the extract, as described in the analytical procedures

## 6.7.9. References

Test Methods for Evaluating Solid Wastes, SW-846, USEPA, 1996 and updates



## **6.8 PHENOLS**

### **6.8.1 Scope and Application**

- i) This method is applicable to the analysis of domestic and industrial wastes.
- ii) The method is capable of measuring phenolic materials at the 5-ug/L levels when the colored end product is extracted and concentrated in a solvent phase using phenol as a standard.
- iii) This method is capable of measuring phenolic materials that contain more than 50 ug/L in the aqueous phase (without solvent extraction using phenol as a standard).
- iv) It is not possible to use this method to differentiate between different kinds of phenols.

### **6.8.2 Principle**

Phenols (Total extractable phenolic compounds) estimation makes use of the reaction of phenols with 4-aminoantipyrine to form a colour complex. The intensity of the colour is directly proportional to the concentration of phenols and thus can be estimated using spectrophotometric technique.

### **6.8.3 Summary of the Method**

- i) Phenolic materials react with 4-aminoantipyrine in the presence of potassium ferricyanide at a pH of 10 to form a stable reddish - brown antipyrine dye. The amount of color produced is a function of the concentration of phenolic material.

### **6.8.4 Interferences**

- i) For most samples a preliminary distillation is required to remove interfering materials.
- ii) Color response of phenolic materials with 4-aminoantipyrine is not the same for all compounds. Because phenolic type wastes usually contain variety of phenols. It is not possible to duplicate a mixture of phenols to be used as a standard.
- iii) For this reason phenol has been selected as a standard and any color produced by the reaction of other phenolic compounds is reported as phenol. This value will represent the minimum concentration of phenolic compounds present in the sample.

- iv) Interferences from sulfur compounds are eliminated by acidifying the sample to a pH of <4 with H<sub>2</sub>SO<sub>4</sub> and aerating briefly by stirring.

### 6.8.5 Apparatus and Materials

- i) Distillation apparatus: All glass, consisting of a 1-liter Pyrex distilling apparatus with Graham condenser. **(Fig.6.3)**
- ii) pH meter
- iii) Spectrophotometer: For use at 460 or 510 nm.
- iv) Funnels
- v) Filter paper
- vi) Membrane filters
- vii) Separatory funnels: 500 or 1000 mL
- viii) Nessler tubes: Short or long form
- ix) Class A volumetric flasks: 100 mL.

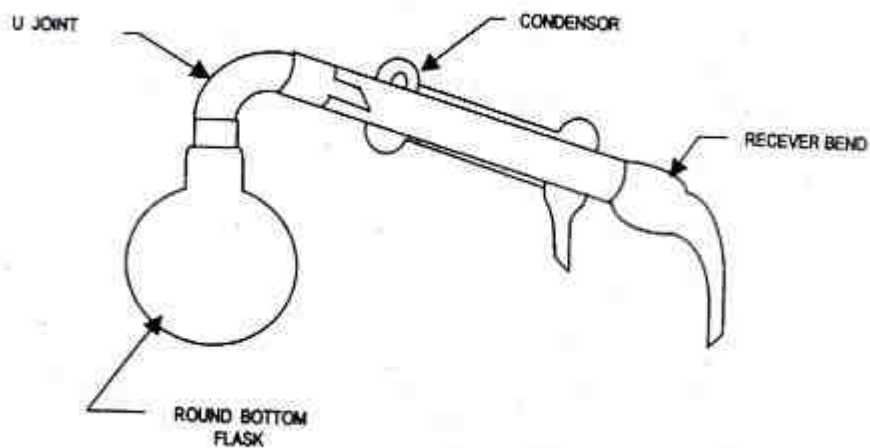

Fig. 6.3 Distillation Assembly

### 6.8.6 Reagents

- i) Reagent grade chemicals shall be used in all tests.
- ii) Reagent water: All references to water in this method refer to reagent water.
- iii) Sulfuric acid solution, H<sub>2</sub>SO<sub>4</sub>: Concentrated.
- iv) Buffer solution: Dissolve 16.9 g of NH<sub>4</sub>Cl in 143 mL concentrated NH<sub>4</sub>OH and dilute to 250 mL with reagent water. Two mL of buffer should adjust 100 mL of distillate to pH 10.
- v) Aminoantipyrine solution: Dissolve 2 g of 4-aminoantipyrine (4-AAP) in reagent water and dilute to 100 mL.
- vi) Potassium ferricyanide solution: Dissolve 8 g of K<sub>3</sub>Fe (CN)<sub>6</sub> in reagent water and dilute to 100 mL.
- vii) Stock phenol solution: Dissolve 1.0 g phenol in freshly boiled and cooled reagent water and dilute to 1 liter (1 mL = 1 mg phenol)  
  
Note: This solution is hygroscopic and toxic.
- viii) Working solution A: Dilute 10 mL stock phenol solution to 1 liter with reagent water (1 mL = 10 µg phenol)
- ix) Working solution B: Dilute 100 mL of working solution A to 1000 mL with reagent water (1 mL = 1 µg phenol).
- x) Chloroform

### 6.8.7 Sample Preparation Method

#### Procedure

- i) Distillation: Measure 500 mL of sample into a beaker. Lower the pH to approximately 4 with concentrated H<sub>2</sub>SO<sub>4</sub> (1mL/L, and transfer to distillation apparatus.
- ii) Distill 450 mL of sample, stop the distillation, and when boiling ceases, add 50 mL of warm reagent water to the flask and resume distillation until 500 mL have been collected. If the distillate is turbid, filter through a pre washed membrane filter.
- iii) Direct photometric method:

- iv) Using working solution A prepare the following standards in 100 mL class A volumetric flasks. A minimum of a blank and three standards must be prepared.

**Table 6.3**

Working Solution A (mL) 10 mg/l	Concentration (mg/L)
0.0	0.0
0.5	0.05
1.0	0.1
2.0	0.2
5.0	0.5
8.0	0.8
10.0	1.0

- v) To 100 mL of distillate or to an aliquot diluted to 100 mL and or standards, add 2 mL of buffer solution and mix. The pH of the sample and standards should be  $10 \pm 0.2$
- vi) Add 2.0-mL aminoantipyrine solution and mix.
- vii) Add 2.0 mL potassium ferricyanide solution and mix.
- viii) After 15 minutes read absorbance at 510 nm.

### 6.8.8 Analytical Procedure

#### Chloroform extraction method:

- i) Standards may be prepared by pipetting the required volumes into the separatory funnels and diluting to 500 mL with reagent water. A minimum of a blank and three standards must be prepared.

**Table 6.4**

Working solution B (mL) 1 mg/l	Concentration (mg/L)
0.0	0.0
3.0	0.006
5.0	0.01
10.0	0.02
20.0	0.04
25.0	0.05

- ii) Place 500 mL of distillate or an aliquot diluted to 500 mL in a separatory funnel. The sample should not contain more than 50 ug/L phenols.

- iii) To sample and standards add 10 mL of buffer solution and mix. The pH should be  $10 \pm 0.2$
- iv) Add 3.0 mL u-aminoantipyrine solution and mix.
- v) Add 3.0 mL potassium ferricyanide solution and mix. after 3 minutes, extract with 25 mL of chloroform. Shake the separatory funnel at least 10 times, let  $\text{CHCl}_3$  settle, shake again 10 times, and let chloroform settle again.
- vi) Filter chloroform extract through filter paper. Do not add more chloroform.
- vii) Read the absorbance of the samples and standards against the blank at 460 nm.

### **6.8.9 Calculatoins**

- i) Prepare standard curve by plotting the absorbance values of standards versus the corresponding phenol concentration.
- ii) Obtain concentration value of sample directly from standard curve.

### **6.8.10 Quality Control**

- i) Calibration curves must be composed of a minimum of a blank and three standards. A calibration curve should be made for every hour of continuous sample analysis.
- ii) Dilute samples if they are more concentrated than the highest standard or if they fall on the plateau of a calibration curve
- iii) After calibrating verify calibration with an independently prepared check standard. The matrix duplicate and matrix spikes are brought through the whole sample preparation and analytical standards.

### **6.8.11 References**

Test Methods for Evaluating Solid Wastes, SW-846, USEPA, 1996 and Updates.

## **6.9 AROMATIC VOLATILE ORGANICS**

### **6.9.1 Scope and Application**

This method is used to determine the concentration of various aromatic volatile organic compounds. Table 6.5 indicates compounds, which may be

determined by this method and lists the method detection limit for each compound in reagent water. Table 6.6 lists the practical quantitation limit (PQL) for other matrices.

### 6.9.2 Summary of the Method

- i) This method provides chromatographic conditions for the detection of aromatic volatile compounds. Samples can be analyzed using direct injection or purge-and-trap. A temperature program is used in the gas chromatograph to separate the organic compounds. Detection is achieved by a photo-ionization detector (PID).
- ii) If interferences are encountered, the method provides an optional gas chromatographic column that may be helpful in resolving the analytes from the interferences and for analyte confirmation.

### 6.9.3 Interferences

- i) Sample can be contaminated by diffusion of volatile organics (particularly chlorofluorocarbons and methylene chloride) through the sample container septum during shipment and storage.
- ii) A field sample blank prepared from reagent water and carried through sampling and subsequent storage and handling can serve as a check on such contamination

### 6.9.4 Apparatus and Materials

Gas Chromatograph: Analytical system complete with gas chromatograph suitable for on-column injections or purge-and-trap sample introduction and all required accessories, including detectors, column supplies, recorder, gasses, and syringes. A data system for measuring peak heights and/or peak areas is recommended.

**Table 6.5**  
**Chromatographic conditions and method detection limits**  
**For aromatic volatile organics**

Compound	Retention time (min)		Method detection limit <sup>a</sup> (ug/L)
	Column 1	Column 2	
Benzene	3.33	2.75	0.2
Chlorobenzene	9.17	8.02	0.2
1,4-Dichlorobenzene	16.8	16.2	0.3
1,3-Dichlorobenzene	18.2	15.0	0.4
1,2-Dichlorobenzene	25.9	19.4	0.4
Ethyl Benzene	8.25	6.25	0.2
Toluene	5.75	4.25	0.2
Xylenes			

<sup>a</sup>: Using purge-and-trap method (Refer Method 5030, SW-846, USEPA)

**Table 6.6**  
**Determination of practical quantitation limits (PQL) For various matrices**

<b>Matrix</b>	<b>Factor<sup>b</sup></b>
Ground water	10
Low-level soil	10
Water miscible liquid waste	500
High-level soil and sludge	1250
Non-water miscible waste	1250

<sup>a</sup>: Sample PQLs are highly matrix-dependent. The PQLs listed herein are provided for guidance and may not always be achievable.

<sup>b</sup>: [Method detection limit (Table 1) x [Factor (Table 2)]]. For non-aqueous samples, the factor is on a wet-weight basis.

**Columns:**

- ii) Column1: 6-ft x 0.082-in I.D.#304 stainless steel or glass column packed with 5% SP-1200 and 1.75% Bentone-34 on 100/120 mesh Supelco or equivalent.
- iii) Column 2: 8-ft x 0.1-in I.D. stainless steel or glass column packed with 5% 1,2,3-Tris (2-cyanoethoxy) propane on 60/80-mesh Chromosorb W-AW or equivalent.
- iv) Detector: Photo ionization (PID) Detector
- v) Sample introduction apparatus:
- vi) Syringes: A 5mL Luerlok glass hypodermic and a 5mL, gas-tight with shutoff valve.
- vii) Volumetric flask: 10,50,100,500 and 1,000 mL with a ground glass stopper.
- viii) Micro syringe: 10 and 25 uL with a 0.006-in I.D. needle (Hamilton 702 N or equivalent) and a 100-µL.

**6.9.5 Reagents**

- i) Reagent water: Reagent water is defined as water in which an interferent is not observed at the method detection limit (MDL) of the parameters of interest.
- ii) Stock standards: Stock solutions may be prepared from pure standard materials or purchased as certified solutions. Prepare stock standards

in methanol using assayed liquids. Because of the toxicity of benzene and 1,4-dichlorobenzene, primary dilutions of these materials should be prepared in a hood.

- iii) Place about 9.8 mL of methanol in a 10mL-tarred ground-glass-stoppered volumetric flask. Allow the flask to stand, unstoppered, for about 10 min or until all alcohol-wetted surfaces have dried. Weigh the flask to the nearest 0.1 mg.
- iv) Using a 100- $\mu$ L syringe, immediately add two or more drops of assayed reference material to the flask; then reweigh. The liquid must fall directly into the alcohol without contacting the neck of the flask.
- v) Reweigh; dilute to volume, stopper, and then mix by inverting the flask several times. Calculate the concentration in micrograms per micro liter ( $\mu\text{g}/\mu\text{l}$ ) from the net gain in weight. When compound purity is assayed to be 96% or greater, the weight may be used without correction to calculate the concentration of the stock standard. Commercially prepared stock standards may be used at any concentration if they are certified by the manufacturer or by an independent source.
- vi) Transfer the stock standard solution into a Teflon-sealed screw-cap bottle. Store, with minimal headspace, at 4<sup>0</sup>C and protect from light.
- vii) All standards must be replaced after 6 months or sooner if comparison with checks standards indicates a problem.
- viii) **Secondary dilution standards:** Using stock standard solutions, prepare in methanol secondary dilution standards, as needed that contain the compounds of interest, either singly or mixed together. The secondary dilution standards should be prepared at concentrations such that the aqueous calibration standards prepared will bracket the working range of the analytical system. Secondary dilution standards should be stored with minimal headspace for volatiles and should be checked frequently for signs of degradation or evaporation, especially just prior to preparing calibration standards from them.
- ix) **Calibration standards:** Calibration standards at a minimum of five concentration levels are prepared in reagent water from the secondary dilution of the stock standards. One of the concentration levels should be at a concentration near, but above, the method detection limit. The remaining concentration levels should correspond to the expected range of concentrations found in real samples or should define the working range of the GC. Each standard should contain each analyte for detection by this method (e.g., some or all of the compounds listed



in Table 1 may be included). In order to prepare accurate aqueous standard solutions, the following precautions must be observed.

- x) Do not inject more than 20- $\mu$ L of alcoholic standards into 100 mL of reagent water.
- xi) Use a 25 $\mu$ L Hamilton 702N micro syringe or equivalent (variations in needle geometry will adversely affect the ability to deliver reproducible volumes of methanolic standards into water).
- xii) Rapidly inject the alcoholic standard into the filled volumetric flask. Remove the needle as fast as possible after injection.
- xiii) Mix aqueous standards by inverting the flask three times only.
- xiv) Fill the sample syringe from the standard solution contained in the expanded area of the flask (do not use any solution contained in the neck of the flask).
- xv) Never use pipettes to dilute or transfer samples or aqueous standards.
- xvi) Aqueous standards are not stable and should be discarded after 1 hour, unless properly sealed and stored. The aqueous standards can be stored up to 24 hr, if held in sealed vials with zero headspace
- xvii) Internal standards (if internal standard calibration is used): To use this approach, the analyst must select one or more internal standards that are similar in analytical behavior to the compounds of interest. The analyst must further demonstrate that the measurement of the internal standard is not affected by method or matrix interferences. Because of these limitations, no internal standard can be suggested that is applicable to all samples. The compound, alpha, alpha, alpha-trifluorotoluene recommended for use as a surrogate spiking compound (paragraph 5.6) has been used successfully as an internal standards.
- xviii) Prepare calibration standards at a minimum of five concentration levels for each parameter of interest. Prepare a spiking solution containing each of the internal standards. It is recommended that the secondary dilution standard be prepared at a concentration of 15  $\mu$ g/mL of each internal standard to 5.0 mL of sample or calibration standard would be equivalent to 30  $\mu$ g/L.
- xix) Analyze each calibration standard according to section 7.0, adding 10  $\mu$ L of internal standard spiking solution directly to the syringe.

- xx) Surrogate standards: The analyst should monitor both the performance of the analytical system and the effectiveness of the method in dealing with each sample matrix by spiking each sample, standard, and reagent water blank with surrogate compounds (e.g., alpha, alpha, alpha-trifluorotoluene) recommended to encompass the range of the temperature program used in this method. From stock standard solutions prepared as in Section 5.2, add a volume to give 750 µg of each surrogate to 45 mL of reagent water contained in a 50-mL volumetric flask, mix, and dilute to volume for a concentration of 15 µg/µL. Add 10 µL of this surrogate spiking solution directly into the 5-mL syringe with every sample and reference standard analyzed. If the internal standard calibration procedure is used, the surrogate compounds may be added directly to the internal standard spiking solution.

Methanol: Pesticide quality or equivalent. Store away from other solvents.

### 6.9.5 Analytical Procedure

#### Gas chromatographic analysis:

Volatile compounds are introduced into the gas chromatograph either by direct injection or purge-and-trap. For medium-level soils or sediments, methanolic extraction, may be necessary prior to purge-and-trap analysis.

#### a) Gas chromatography conditions (Recommended)

- i) Column 1: Set helium gas flow at 36-mL/min-flow rate. The temperature program sequences are as follows: For lower boiling compounds, operate at 50<sup>0</sup>C isothermal for 2 min; then program at 6<sup>0</sup>C/min to 90<sup>0</sup>C and hold until all compounds have eluted. For higher boiling range of compounds, operate at 50<sup>0</sup>C isothermal for 2 min; then program at 3<sup>0</sup>C/min to 110<sup>0</sup>C and hold until all compounds have eluted. Column 1 provides outstanding separations for a wide variety of aromatic hydrocarbons. Column 1 should be used as the primary analytical column because of its unique ability to resolve Para-, meta-, and ortho-aromatic isomers.
- ii) Column 2: Set helium gas flow at 30-mL/min-flow rate. The temperature program sequence is as follows: 40<sup>0</sup>C isothermal for 2 min; then 2<sup>0</sup>C/min to 100<sup>0</sup>C and hold until all compounds have eluted. Column 2, an extremely high-polarity column, has been used for a number of years to resolve aromatic hydrocarbons from alkanes in complex samples. However, because resolution between some of the aromatics is not as

efficient as with column 1, and column 2 should be used as a confirmatory column.

iii) Calibration must take place using the same sample introduction method that will be used to analyze actual samples.

iv) The procedure for internal calibration may be used.

**b) Gas chromatographic analysis**

i) Introduce volatile compounds into the gas chromatograph using either method (purge-and-trap method) or the direct injection method. If the internal standard calibration technique is used, add 10 uL of internal standard to the sample prior to purging.

ii) Direct injection: In very limited applications (e.g., aqueous process wastes), direct injection of the sample into the GC system with a 10-uL syringe may be appropriate. The detection limit is very high (approximately 10,000 µg/L); therefore, it is only permitted when concentrations in excess of 10,000 µg/L are expected or for water-soluble compounds that do not purge. The system must be calibrated by direct injection (bypassing the purge-and-trap device).

iii) Include a mid-level standard after each group of 10 samples in the analysis sequence.

iv) Table 6.5 & 6.6 summarizes the estimated retention times and detection limits for a number of organic compounds analyzable using this method.

v) Record the sample volume purged or injected and the resulting peak sized. (In area units or peak heights.)

vi) If analytical interferences are suspected, or for the purpose of confirmation, analysis using the second GC column is recommended.

vii) If the response for a peak is off-scale, prepare a dilution of the sample with reagent water. The dilution must be performed on a second aliquot of the sample, which has been properly sealed and stored prior to use.

**6.9.9 Quality Control**

i) Adopt appropriate quality control procedures to validate GC system and method.

- ii) Calculate surrogate standard recovery on all samples, blanks, and spikes. Determine if recovery is within limits.
- iii) If recovery is not within limits, the following is required.
- iv) Check to be sure there are no errors in calculations, surrogate solutions and internal standards. Also, check instrument performance. Recalculate the data and/or reanalyze the extract if any of the above checks reveal a problem.
- v) Re-extract and reanalyze the sample if none of the above are a problem or flag the data as "estimated concentration".

#### **6.9.10 References**

1. Test Methods for Evaluating Solid Wastes, SW-846, USEPA, 1996 and Updates.

### **6.10 Nonhalogenated volatile organics**

#### **6.10.1 Scope and Application**

This method is used to determine the concentration of various nonhalogenated volatile organic compounds. Table 6.7 indicates the compounds that may be investigated by this method.

#### **6.10.2 Summary of the Method**

- i) This method provides gas chromatographic conditions for the detection of certain nonhalogenated volatile organic compounds. Samples may be analyzed using direct injection or purge-and-trap. Ground water samples must be analyzed by method purge-and-trap. A temperature program is used in the gas chromatograph to separate the organic compounds. Detection is achieved by a flame ionization detector (FID).
- ii) If interferences are encountered, the method provides an optional gas chromatographic column that may be helpful in resolving the analytes from interferences that may occur and for analyte confirmation.

#### **6.10.3 Interferences**

- i) Samples can be contaminated by diffusion of volatile organics (particularly chlorofluorocarbons and methylene chloride) through the sample container septum during shipment and storage. A field sample blank prepared from reagent water and carried through sampling and

subsequent storage and handling can serve as a check on such contamination.

#### 6.10.4 Apparatus and Materials

- i) Gas chromatograph: Analytical system complete with gas chromatograph suitable for on-column injections or purge-and-trap sample introduction and all required accessories, including detectors, column supplies, recorder, gasses, and syringes. A data system for measuring peak heights and/or peak areas is recommended.
- ii) Columns: Column 1: 8-ft x 0.1-in I.D. stainless steel or glass column packed with 1% SP-1000 on Carborab-B 60/80 mesh or equivalent.
- iii) Column 2: 6-ft x 0.1-in I.D. stainless steel or glass column packed with n-octane on Porasil-C 100/120 mesh 9Durapak) or equivalent.

**Table-6.7**  
**Nonhalogenated Volatile Organics**

S.No	Name of compound
1.	Acryl amide
2.	Diethyl ether
3.	Ethanol
4.	Methyl ethyl ketone (MEK)
5.	Methyl isobutyl ketone (MIBK)
6.	Paraldehyde (trimer of acetaldehyde)

- i) Detector: Flame ionization (FID)
- ii) Sample introduction apparatus: Refer to method 5030 for the appropriate equipment for sample introduction purposes.
- iii) Syringes: a 5-mL Luerlok glass hypodermic and a 5-mL, gas-tight with shutoff valve.
- iv) Volumetric flask: 10, 50, 100, 500, and 1,000 mL with a ground glass stopper.
- v) Micro syringe: 10 and 25  $\mu\text{L}$  with a 0.006-in I.D. needle (Hamilton 702N or equivalent) and a 100 $\mu\text{L}$ .

#### 6.10.5 Reagents

- i) Reagent water: Reagent water is defined as water in which an interferent is not observed at the method detection limit (MDL) of the analytes of interest.

- ii) Stock standards: Stock solutions may be prepared from pure standard materials or purchased as certified solutions. Prepare stock standards in methanol using assayed liquids
- iii) Place about 9.8 mL of methanol in a 10-mL tarred ground-glass-stoppered volumetric flask. Allow the flask to stand, unstoppered, for about 10 min or until all alcohol-wetted surfaces have dried. Weigh the flask to the nearest 0.1 mg.
- iv) Using a 100- $\mu$ L syringe, immediately add two or more drops of assayed reference material to the flask; then reweigh. The liquid must fall directly into the alcohol without contacting the neck of the flask.
- v) Reweigh, dilute to volume, stopper, and then mix by inverting the flask several times. Calculate the concentration in micrograms per micro liter ( $\mu\text{g}/\mu\text{L}$ ) from the net gain in weight. When compound purity is assayed to be 96% or greater, the weight may be used
- vi) Without correction to calculate the concentration of the stock standard. Commercially prepared stock standards may be used at any concentration if they are certified by the manufacturer or by an independent source.
- vii) Transfer the stock standard solution into a Teflon-sealed screw-cap bottle. Store, with minimal headspace, at  $-10^{\circ}\text{C}$  to  $20^{\circ}\text{C}$  and protect from light.
- viii) Standards must be replaced after 6 months, or sooner if comparison with checks standards indicates a problem.
- ix) Secondary dilution standards: Using stock standard solutions, prepare in methanol secondary dilution, as needed, that contain the compounds of interest, either singly or mixed together. The secondary dilution standards should be prepared at concentrations such that the aqueous calibration standards prepared in Section 5.4 will bracket the working range of the analytical system. Secondary dilution standards should be stored with minimal headspace for volatiles and should be checked frequently for signs of degradation or evaporation, especially just prior to preparing calibration standards from them.
- x) Calibration standards: Calibration standards at a minimum of five concentration levels are prepared in reagent water from the secondary dilution of the stock standards. One of the concentration levels should be at a concentration near, but above, the method detection limit. The remaining concentration levels should correspond to the expected range of concentrations found in real samples or should define the working range of the GC. Each standard should contain each analyte

for detection by this method (e.g., some or all of the compounds listed in Table 1 may be included). In order to prepare accurate aqueous standard solutions, the following precautions must be observed.

- xi) Do not inject more than 20  $\mu\text{L}$  of alcoholic standards into 100mL of reagent water.
- xii) Use a 25- $\mu\text{L}$  Hamilton 702N micro syringe or equivalent (variations in needle geometry will adversely affect the ability to deliver reproducible volumes of methanolic standards into water.
- xiii) Rapidly inject the alcoholic standard into the filled volumetric flask. Remove the needle as fast as possible after injection.
- xiv) Mix aqueous standards by inverting the flask three times only.
- xv) Fill the sample syringe from the standard solution contained in the expanded area of the flask (do not use any solution contained in the neck of the flask.)
- xvii) Never use pipettes to dilute or transfer samples or aqueous standards
- xvii) Aqueous standards are not stable and should be discarded after 1 hr, unless properly sealed and stored. The aqueous standards can be stored up to 24 hr, if held in sealed vials with zero headspace.
- xviii) Internal standards (if internal standard calibration is used): To use this approach, the analyst must select one or more internal standards that are similar in analytical behavior to the compounds of interest. The analyst must further demonstrate that the measurement of the internal standard is not affected by method or matrix interferences. Because of these limitations, no internal standard can be suggested that is applicable to all samples.
- xix) Prepare calibration standards at a minimum of five concentration levels for each parameter of interest as described earlier.
- xx) Prepare a spiking solution containing each of the internal standards using the procedures. It is recommended that the secondary dilution standard be prepared at a concentration of 15  $\mu\text{g}/\text{mL}$  of each internal standard compound. The addition of 10  $\mu\text{L}$  of this standard to 5.0 mL of sample or calibration standard would be equivalent to 30  $\mu\text{g}/\text{L}$
- xxi) Analyze each calibration standard according to adding 10  $\mu\text{L}$  internal standard spiking solution directly to the syringe.

- xxii) Surrogate standards: The analyst should monitor both the performance of the analytical system and the effectiveness of the method in dealing with each sample matrix by spiking each sample, standard, and reagent water blank with one or two surrogate compounds recommended to encompass the solutions prepared as in Section 5.2, add a volume to give 750 ug of each surrogate to 45 mL of reagent water contained in a 50-mL volumetric flask, mix, and dilute to volume for a concentration of 15 ng/ $\mu$ L. Add 10  $\mu$ L of this surrogate spiking solution directly into the 5-mL syringe with every sample and reference standard analyzed. If the internal standard calibration procedure is used, the surrogate compounds may be added directly to the internal standard spiking solution.
- xxiii) Methanol: Pesticide quality or equivalent. Store away from other solvents.

### 6.10.6 Analytical Procedure

#### Gas chromatographic analysis:

##### a) Procedure

- i) Volatile compounds are introduced into the gas chromatograph either by direct injection or purge-and-trap. Purge and trap may be used directly on ground water samples or low-level contaminated soils and sediments. For medium-level soils and sediments.
- ii) For medium-level soils or sediments, methanolic extraction, may be necessary prior to purge-and-trap analysis.

##### b) Gas chromatography conditions (Recommended)

- i) Column 1: Set helium gas flow at 40-mL/min-flow rate. Set column temperature at 45<sup>0</sup>C for 3 min; then program an 8<sup>0</sup>C/min-temperature rise to 220<sup>0</sup>C and hold for 15 min.
- ii) Column 2: Set helium gas flow at 40-mL/min-flow rate. Set column temperature at 50<sup>0</sup>C for 3 min; then program a 6<sup>0</sup>C/min-temperature rise to 170<sup>0</sup>C and hold for 4 min.
- iii) Calibration must take place using the same sample introduction method that will be used to analyze actual samples.
- iv) The procedure for internal or external calibration may be used.
- v) Gas chromatographic analysis



- vi) Introduce volatile compounds into the gas chromatograph using either Method (purge-and-trap method) or the direct injection method. If the internal standard calibration technique is used, add 10  $\mu\text{L}$  of internal standard to the sample prior to purging.
- vii) Direct injection: In very limited applications (e.g., aqueous process wastes), direct injection of the sample into the GC application is for verification of the alcohol content of an aqueous sample prior to determining if the sample is ignitable (Method 1010 or 1020). In this case, it is suggested that direct injection be used. The detection limit is very high (approximately 10,000  $\mu\text{g/L}$ ); therefore, it is only permitted when concentrations in excess of 10,000  $\mu\text{g/L}$  are expected or for water-soluble compounds that do not purge. The system must be calibrated by direct injection (by passing the purge-and-trap device.)
- viii) Record the sample volume purged or injected and the resulting peak sizes (in area units or peak heights).
- ix) Calculation of concentration is covered.
- x) If analytical interferences are suspected, or for the purpose of confirmation, analysis using the second GC column is recommended.
- xi) If the response for a peak is off-scale, prepare a dilution of the sample with reagent water. The dilution must be performed on a second aliquot of the sample which has been properly sealed and stored prior to use.

#### **6.10.7 Quality Control**

- i) Calculate surrogate standard recovery on all samples, blanks, and spikes. Determine if recovery is within limits.
- ii) If recovery is not within limits, the following is required.
- iii) Check to be sure there are no errors in calculations, surrogate solutions and internal standards. Also, check instrument performance.
- iv) Recalculate the data and/or reanalyze the extract if any of the above checks reveal a problem.
- v) Reextract and reanalyze the sample if none of the above are a problem or flag the data as "estimated concentration".

## 6.10.7 References

Test Methods for Evaluating Solid Wastes, SW-846, 1996 and Updates

## 6.11 ELEMENTAL ANALYSIS (C10, D6, D7)

### 6.11.1 Principle:

In general the elemental analyzers works based on principle of catalytic tube combustion in an oxygenated CO<sub>2</sub> atmosphere and high temperatures. The combustion gases are freed from foreign gases (for instance volatile halogens). The desired measuring components are separated from each other with the help of specific adsorption columns determined in succession with a thermal conductivity detector (TCD). Helium serves as flushing and carrier gas.

### 6.11.2 Summary of the procedure

- i) The substance to be analyzed is weighed in a tin boat (tin capsules available for liquid samples) and digested through oxidative combustion. The quantitative substance digestion is based on the principle of the explosive combustion in an oxygenated helium atmosphere in a combustion tube at a temperature of approximately 1150<sup>0</sup>c. The oxidative combustion of the elements C, H, N and S produces apart from the molecular nitrogen, the oxidation products CO<sub>2</sub>, H<sub>2</sub>O, NO, NO<sub>2</sub>, SO<sub>2</sub>, SO<sub>3</sub>, as well as volatile halogen compounds, if the sample contains halogens.
- ii) A copper contact reduction tube switched in sequence quantitatively reduces the nitrogen oxides and sulphur oxides at 850<sup>0</sup>c.to molecular nitrogen, SO<sub>2</sub> and binds excess oxygen. Following the volatile halogen compounds are chemically bound by suitable absorbents (e.g. silver wool) and thus removed from the gas flow.
- iii) The remaining gas mixture of helium, CO<sub>2</sub>, H<sub>2</sub>O, N<sub>2</sub> and SO<sub>2</sub> components is sequentially guided to a separation and measuring system. All connecting tubes leading to the separation system are heated to prevent H<sub>2</sub>SO<sub>4</sub> being produced from SO<sub>2</sub> and H<sub>2</sub>O, and to avoid condensation occurring in the tube passages.

### 6.11.3 Interferences:

- i) Alkali and alkaline earth metals may interfere in combustion. Tungsten trioxide inside the combustion tube works as catalyst in order to bind alkaline earth elements and to avoid non-volatile sulfates.

- ii) Halogens are the potential interferences in elemental analysis; to overcome this interference silver wool in the reduction tube is helpful.

#### **6.11.4 Procedure:**

- i) Open the gas and keep the pressure as per instructions
- ii) Set the temperatures for furnaces as per the manufacturers instruction.
- iii) Allow system to attain the temperatures and start analysis.
- iv) The operation of elemental analyzer is to be strictly followed as per the manufactures instructions, however the general procedure is given below.
- v) Weigh the samples in tin boats, (solid samples) or tin capsules (liquids) together with the WO<sub>3</sub> additive and then put in the carousel of the automatic sample feeder. The tin boats must be folded into cube shaped packets and press them flat. Press for sealing the capsule with the device supplied by the manufacturer.
- vi) Enter the sample weight into the PC either from an on-line balance, or manually with the keyboard.
- vii) Carry out auto zero adjustment prior to analysis.
- viii) Now feed the sample in to the analyzer.
- ix) Sample will be dropped into the ash finger with the help of ball valve movements.
- x) With pc manipulations and other factors result will be displayed on monitor.
- xi) The % C, H, N, S can be seen from the read out finally.

### **6.12 N-HEXANE EXTRACTABLE MATERIAL (HEM) FOR SLUDGE, SEDIMENT, AND SOLID SAMPLES (B22- Drilling, cutting, grinding, and rolling oil or emulsions thereof)**

#### **6.12.1 Scope and Application**

- a) This method may be used to quantify low concentrations of oil and grease in soil, sediments, sludges, and other solid materials amenable to chemical drying and solvent extraction with n-hexane. This method employs n-hexane as the extraction solvent with Soxhlet extraction and the results of

this method are appropriately termed “n-hexane extractable material (HEM).”

- b) This method is suitable for extracting relatively non-volatile hydrocarbons, vegetable oils, animal fats, waxes, soaps, greases, biological lipids, and related materials.
- c) This method is not recommended for measuring materials that volatilize at temperatures below 85<sup>0</sup>C. Petroleum fuels from gasoline through #2 fuel oil may be partially lost during the solvent removal process.
- d) Some crude oils and heavy fuel oils may contain materials that are not soluble in n-hexane, and recovery of these materials may be low.

### 6.12.2 Summary of Method

- a) A representative portion of wet (as received) waste is acidified with concentrated HCl and chemically dried with magnesium sulfate or sodium sulfate. Magnesium sulfate monohydrate is used to dry acidified sludges as it will combine with 75% of its own weight in water in forming
- b) MgSO<sub>4</sub> 7H<sub>2</sub> O. Anhydrous sodium sulfate is used to dry soil and sediment samples.
- c) After drying, the HEM is extracted with n-hexane using a Soxhlet apparatus. The n-hexane extract is then distilled from the extract and the HEM is desiccated and weighed. When necessary, a separate sample portion is evaluated for percent solids, and the dry weight fraction may be used to calculate the dry-weight HEM concentration of the soil, sediment, or waste.

### 6.12.3 Interferences

- a) Solvents, reagents, glassware, and other sample-processing hardware may yield artifacts that could affect the results. All solvents and reagents used in the analysis should be demonstrated to be free from interferences by processing a method blank with each analytical batch.
- b) Specific selection of reagents, solvent washes, or purification of solvents may be required. Use of plastic measuring devices, and/or plastic tubing attachments must be avoided.
- c) Glassware should be cleaned by washing with hot tap water with detergent, rinsing with tap water and reagent water, and rinsing with solvent. Glassware may also be baked at 200-250<sup>0</sup>C for 1 hour. Boiling flasks that are used to contain the extracted residues may be dried in an oven at 105-115<sup>0</sup>C and stored in a desiccator until used.

- d) Extracted residues should be maintained in a desiccator during cooling and prior to weighing. Extracted residues should be weighed as soon as possible after cooling.
- e) The presence of non-oily extractable substance such as sulfur compounds, organic dyes, and chlorophyll, may result in a positive bias. For the purpose of this method, all materials extracted and retained during this procedure are defined as HEM.
- f) Unknown samples may contain high concentrations of volatile toxic compounds. Sample containers should be opened in a hood and handled with gloves to prevent exposure.

#### **6.12.4 Equipment and Supplies**

- a) Soxhlet extraction apparatus.
- b) Heating mantle - explosion-proof, with temperature control.
- c) Boiling flask - 125-mL or appropriate size.
- d) Analytical balance - capable of weighing 0.1 mg.
- e) Vacuum pump, or other vacuum source.
- f) Paper extraction thimble for Soxhlet apparatus.
- g) Glass wool or small glass beads to fill thimble.
- h) Grease-free, non-absorbent cotton - To remove possible interferences, each batch of cotton should be washed with n-hexane.
- i) Beakers - 100- 150-mL.
- j) pH paper.
- k) Porcelain mortar and pestle.
- l) Extraction flask - 150-mL or appropriate size.
- m) Waterbath or steam bath-explosion-proof - capable of maintaining a temperature of at least 85<sup>0</sup>C.
- n) Distilling apparatus - For removing n-hexane from extract.

- o) Distilling head-Claisen (VWR Scientific No 26339-005, or equivalent), includes Claisen-type connecting tube and condenser.
- p) Distillation adapter (used to attach distilling head and to the waste collection flask for recovery of solvent).
- q) Distillate collection flask (attached to the distilling adaptor for collection of the distilled solvent).
- r) Ice bath or recirculating chiller (to aid in the condensation and collection of the distilled solvent).
- s) Desiccator - Cabinet or jar type, capable of holding boiling flasks during cooling and storage.
- t) Tongs - for handling the boiling flasks.
- u) Glass fiber filter paper - Whatman No. 40 or equivalent.
- v) Boiling chips - Silicon carbide or fluoropolymer.

#### 6.12.5 Reagents

- a) Use Reagent grade chemicals in all tests
- b) DDW
- c) Concentrated hydrochloric acid (HCl).
- d) Magnesium sulfate monohydrate. Prepare  $\text{MgSO}_4 \cdot \text{H}_2\text{O}$  by spreading a thin layer in a 4 2 a dish and drying in an oven at  $150^\circ\text{C}$  overnight. Store in a tightly sealed glass container until used
- e) Sodium sulfate, granular, anhydrous ( $\text{Na}_2\text{SO}_4$ ). Purify by heating at  $400^\circ\text{C}$  for 4 hours
- f) n-Hexane. Purity of 85%, 99.0% minimum saturated C isomers, residue less than 1.6 mg/L. Boiling point,  $69^\circ\text{C}$ .

#### 6.12.6 Sample Collection, Preservation, and Storage

- a) A minimum of 100 grams of sample should be collected using a metal spatula, spoon, into a pre-cleaned wide-mouth glass container fitted with a TFE-lined screw cap.
- b) The sample should be preserved to a  $\text{pH} < 2$  by adding 1 mL of concentrated HCl per 100 gram of sample and cooled to  $4 \pm 2^\circ\text{C}$ . If

acidification is not practical (as with a dry soil), the addition of the HCl is not required and the sample should be cooled to  $4 \pm 2^{\circ}\text{C}$ .

- c) A holding time has not been established for HEM in solids, but it is recommended that the sample be analyzed as soon as possible.

#### **6.12.7 Quality Control**

- a) Run one matrix duplicate and matrix spike sample every twenty samples or analytical batch, whichever is more frequent. Matrix duplicates and spikes are brought through the whole sample preparation and analytical process.
- b) The performance of the method should be evaluated by the use of a Laboratory Control Sample (LCS). The LCS is prepared by spiking an inert matrix (as pre-cleaned sand or similar material) with an appropriate volume of spiking solution and carrying it through the analytical process.

#### **6.12.8 Calibration and Standardization**

- a) Calibrate the analytical balance at 2 mg and 1000 mg using class "S" weights.

#### **6.12.9 Procedure**

- a) Determination of Sample Dry Weight Fraction
- b) When it is necessary to report the HEM on a dry weight basis, determine the dry weight fraction using a separate aliquot of sample, as discussed below.
- c) Weigh 5-10 gram ( $\pm 0.01$  gram) of the sample into pre-weighed crucible.
- d) Determine the weight of the wet sample by subtracting the weight of the crucible. Place the crucible with the wet sample in an oven overnight at  $105^{\circ}\text{C}$
- e) Remove crucible from oven and place in a desiccators to cool. Weigh. Determine dry weight of sample by subtracting the weight of the crucible. Determine the dry weight fraction of the sample as follows:
- f) Dry weight fraction = g of dry sample/ g of sample

#### **6.12.10 Sample Preparation**

- a) Sludge/Waste Samples

- b) Weigh out  $20 \pm 0.5$  grams of wet sample into a 150-mL beaker.
- c) If the sample has not been acidified, acidify to a pH # 2 with approximately 0.3 mL concentrated HCl.
- d) Add 25 grams  $\text{Mg SO}_4 \text{ H}_2\text{O}$  and stir to a smooth paste.
- e) Spread paste on sides of beaker to facilitate evaporation. Let stand about 15-30 min or until material is solidified.
- f) Remove solids and grind to fine powder in a mortar.
- g) Add the powder to the paper extraction thimble.
- h) Wipe beaker and mortar with pieces of filter paper moistened with n-hexane and add to thimble. Fill thimble with glass wool (or glass beads).

#### **6.12.11 Sediment/Soil Samples**

- a) Decant and discard any water layer on a sediment sample. Mix sample thoroughly, especially composited samples. Discard any foreign objects such as sticks, leaves, and rocks.
- c) Blend 10 grams of the sample with 10 grams of anhydrous sodium Sulfate. Transfer homogenized paste to an extraction thimble and cover with glass wool or glass beads.

The extraction thimble must drain freely for the duration of the extraction period.

#### **6.12.12 Extraction**

- a) Set-up the Soxhlet apparatus containing the extraction thimble and sample and attach a 125-mL boiling flask containing 90 mL of n-hexane. Add boiling chips. Adjust the heating control on the heating mantle so that a cycling rate of 20 cycles/h is obtained. Extract for a period of 4 hrs.
- b) Tare a clean 250-mL or appropriate sized boiling flask as follows:
- c) Dry the flask in an oven at  $105\text{-}115^{\circ}\text{C}$  for a minimum of 2 h.
- d) Remove from the oven and immediately transfer to a desiccator to cool at room temperature.
- e) When cool, remove from the desiccator with tongs and weigh immediately on a calibrated balance.



- f) At the end of the 4 h extraction period, filter the extract through grease-free cotton, into the pre-weighed boiling flask.
- g) Rinse flask and cotton with n-hexane and add to the 250-mL boiling flask.
- h) NOTE: If the extract is clear and no suspended particles are present, the filtration step may be omitted.
- i) Connect the boiling flask to the distilling head apparatus and distill the solvent by immersing the lower half of the flask in a water bath or a steam bath. A heating mantle may also be used. Adjust the temperature of the heating device to complete the distillation in less than 30 minutes. Collect the solvent for reuse or appropriate disposal.
- j) When the distillation is complete, remove the distilling head. Immediately remove the flask from the heat source and wipe the outside to remove excess moisture and fingerprints.
- k) Cool the boiling flask in a desiccators for 30 min and weigh. Determine the gain in weight of the boiling flask by subtracting the weight of the boiling flask from the final boiling flask weight.

### 6.12.13 Calculations

Calculate the concentration of HEM in the sample as follows:

$$\text{HEM (mg/Kg wet weight)} = \frac{\text{Gain in weight of flask (mg)} \times 1000}{\text{weight of wet solid (g)}}$$

Calculate the HEM (mg/kg) on dry weight basis using the calculations presented in Chapter 4.

## CHAPTER 7

# METHODS FOR THE DETERMINATION OF HAZARDOUS CHARACTERISTICS OF WASTES

### 7.1 INTRODUCTION

Schedule-3 (Part - B) of the rules identified fourteen hazardous characteristics of wastes. Methods for the determination of the listed hazardous characteristics are presented in this chapter.

#### 7.1.1 Explosives (H1)

##### Regulatory Definition

An explosive substance or waste is a solid or liquid substance or waste (or mixture of substances or wastes) which is in itself capable by chemical reaction of producing gas at such a temperature and pressure and at such speed as to cause damage to the surroundings.

*Method reserved for the updation of this manual*

#### 7.1.2 Flammable Liquids (H3)

##### Regulatory Definition

The word "flammable" has the same meaning as "inflammable". Flammable liquids are liquids, or mixture of liquids, or liquids containing solids in solution or suspension (for example, paints, varnishes, lacquers, etc., but not including substances or wastes otherwise classified on account of their dangerous characteristics) which give off a flammable vapor at temperatures of not more than 60.5 degrees centigrade, closed-cup test, or not more than 65.6 degrees centigrade, open-cup test. (Since the results of open-cup tests and of closed-cup tests are not strictly comparable and even individual results by the same test are often variable, regulations varying from the above figures to make allowance for such differences would be within the spirit of this definition).

#### 7.1.3 Flammable Solids (H4.1)

##### Regulatory Definition

Solids, or waste solids, other than those classed as explosives, which under conditions encountered in transport are readily combustible, or may cause or contribute to fire through friction; self-reactive and related substances which are liable to undergo a strongly exothermic reaction.

*Method reserved for the updation of this manual*

#### **7.1.4 Substances or Wastes Liable to Spontaneous Combustion (H4.2)**

##### **Regulatory Definition**

Substances or wastes which are liable to spontaneous heating under normal conditions encountered in transport, or to heating up on contact with air, and being then liable to catch fire.

*Method reserved for the updation of this manual*

#### **7.1.5 Substances or Wastes, in Contact With Water Emit Flammable Gases (H4.3)**

##### **Regulatory Definition**

Substances or wastes, which by interaction with water, are liable to become spontaneously flammable or to give off flammable gases in dangerous quantities.

*Method reserved for the updation of this manual*

#### **7.1.6 Oxidizing (H5.1)**

##### **Regulatory Definition**

Substances or wastes which, while in themselves not necessarily combustible, may, generally by yielding oxygen causes, or contribute to, the combustion of other materials.

*Method reserved for the updation of this manual*

#### **7.1.7 Organic Peroxides (H5.2)**

##### **Regulatory Definition**

Organic substances or wastes that contain the bivalent -O-O- structure are thermally unstable substances which may undergo exothermic self-accelerating decomposition.

*Method reserved for the updation of this manual*

#### **7.1.8 Poisonous (Acute) (H6.1)**

##### **Regulatory Definition**

Substances or wastes liable either to cause death or serious injury or to harm health if swallowed or inhaled or by skin contact.

*Method reserved for the updation of this manual*

### **7.1.9 Infectious Substances (H6.2)**

#### **Regulatory Definition**

Substances or wastes containing viable microorganisms or their toxins, which are known or suspected to cause disease in animals or humans.

#### **Methodology for the Determination**

Bio-medical Waste (Management & Handling) Amendment Rules, 2000 shall apply.

### **7.1.10 Corrosives (H8)**

#### **Regulatory Definition**

Substances or wastes which, by chemical action, will cause severe damage when in contact with living tissues, or, in the case of leakage, will materially damage or even destroy, other goods or the means of transport; they may also cause other hazards.

### **7.1.11 Liberation of Toxic Gases in Contact With Air or Water (H10)**

#### **Regulatory Definition**

Substances or wastes, which, by interaction with air or water, are liable to give off toxic gases in dangerous quantities.

### **7.1.12 Toxic (Delayed or Chronic) (H11)**

#### **Regulatory Definition**

Substances or wastes which, if they are inhaled or ingested or if they penetrate the skin, may involve delayed or chronic effects, including carcinogenicity.

### **7.1.13 Ecotoxic (H12)**

#### **Regulatory Definition**

Substances or wastes which if released present or may present immediate or delayed adverse impacts to the environment by means of bioaccumulation and/or toxic effects upon biotic systems.

*CAPABLE BY ANY MEANS AFTER DISPOSAL OF YIELDING ANOTHER MATERIAL, EG, LEACHATE WITH POSSESSES ANY OF THE CHARACTERISTICS LISTED ABOVE*

## 7.2 SETAFLASH CLOSED-CUP METHOD FOR DETERMINING IGNITABILITY

### 7.2.1 Scope and Application

- i) This method makes use of the Seta flash Closed Tester to determine the flash point of liquids that have flash points between 0<sup>o</sup> and 110<sup>o</sup>C (32<sup>o</sup> and 230<sup>o</sup>F) and viscosities lower than 150 stokes at 25<sup>o</sup>C (77<sup>o</sup>F).
- ii) The procedure may be used to determine whether a material will or will not flash at a specified temperature or to determine the finite temperature at which a material will flash.
- iii) Liquids that tend to form surface films under the test conditions or those that contain non-filterable suspended solids shall be tested for ignitability using Method (Pen sky-Martens Closed-Cup)

### 7.2.2 Summary of Method

- i) By means of a syringe, 2-mL of sample is introduced through a leak proof entry port into the tightly closed Seta flash Tester or directly into the cup, which has been brought to within 3<sup>o</sup>C below the expected flash point.
- ii) As a flash/no-flash test, the expected flash-point temperature may be a specification (e.g., 60<sup>o</sup>C). For specification testing, the temperature of the apparatus is raised to the precise temperature of the specification flash point by slight adjustment of the temperature dial. After 1 min, a test flame is applied inside the cup and note is taken as to whether the test sample flashes or not. If a repeat test is necessary, a fresh sample should be used.
- iii) For a finite flash measurement, the temperature is sequentially increased through the anticipated range, the test flame being applied at 5<sup>o</sup>C intervals until a flash is observed. A repeat determination is then made using a fresh sample, starting the test at the temperature of the last interval before the flash point of the material and making tests at increasing 0.5<sup>o</sup>C intervals

---

Ref: Method 1020, Setaflash closed-cup method for determining ignitability

## 7.3 PENSKY-MARTENS CLOSED-CUP METHOD FOR DETERMINING IGNITABILITY

### 7.3.1 Scope

This uses the Pen sky-Martens closed-cup tester to determine the flash point of liquids including those that tend to form a surface film under test conditions.

Liquids containing non-filterable, suspended solids shall also be tested using this method.

### 7.3.2 Summary of Method

The sample is heated at a slow, constant rate with continual stirring. A small flame is directed into the cup at regular intervals with simultaneous interruption of stirring. The flash point is the lowest temperature at which application of the test flame ignites the vapor above the sample.

### 7.3.3 Method Performance

The Pen sky-Martens and Seta flash Closed Testers were evaluated using five industrial waste mixtures and p-xylene. The results of this study are shown below in °F along with other data.

Sample	Pensky-Martens	Setaflash
12	143 <u>+1.5</u>	139.3 <u>+2.1</u>
22	144.7 <u>+4.5</u>	129.7 <u>+0.6</u>
32	93.7 <u>+1.5</u>	97.7 <u>+1.2</u>
42	198.0 <u>+4.0</u>	185.3 <u>+0.6</u>
52	119.3 <u>+4.0</u>	122.7 <u>+ 2.5</u>
p-xylene <sup>2</sup>	81.3 <u>+1.1</u>	79.3 <u>+0.6</u>
p-xylene <sup>3</sup>	77.7 <u>+0.5<sup>a</sup></u>	--
Tanker oil	125,135	--

---

Ref: Method 1010, Pen Sky-Martens closed-cup method for determining ignitability

## H8- Corrosives:

### 7.4 pH ELECTROMETRIC MEASUREMENT

#### 7.4.1 Scope and application

- i) This method is used to measure the pH of aqueous wastes and those multiphasewastes where the aqueous phase constitutes at least 20% of the total volume of the waste.
- ii) The corrosivity of concentrated acids and bases, or mixed with inert substances, cannot be measured. The pH measurement requires some water content.

## 7.4.2 Summary

The pH of the sample is measured electrometrically using either a glass electrode in combination with a reference potential or a combination electrode. The measuring device is calibrated using a series of standard solutions of known pH.

## 7.4.3 Interferences

- i) The glass electrode in general, is not subject to solution interference's from color, turbidity, colloidal matter, oxidants, reductants, or moderate (<0.1 molar solution) salinity.
- ii) Sodium error at pH levels >10 can be reduced or eliminated by using a low- sodium –error electrode.
- iii) Coatings of oily material or particulate matter can impair electrode response. These coatings can usually be removed by gentle wiping or detergent washing, followed by rinsing with distilled water. An additional treatment with (1:10) hydrochloric acid may be necessary to remove any remaining film.
- iv) Temperature effects on the electrometric determination of pH arise from two sources. The first is caused by the change in electrode output at various temperatures. This interference should be controlled with instruments having temperature compensation or by calibrating the electrode-instrument system at the temperature of the samples. The second source of temperature effects is the change of pH due to changes in the sample as the temperature changes. This error is sample-dependent and cannot be controlled. It should, therefore, be noted by reporting both the pH and temperature at the time of analysis.

## 7.4.4 Apparatus and materials

- i) pH meter: Laboratory or field model.
- ii) Glass electrode.
- iii) Reference electrode: silver –silver chloride or other reference electrode of constant potential may be used.
- iv) Magnetic stirrer and Teflon- coated stirring bar.
- v) Thermometer and/or temperature sensor for automatic compensation.

#### 7.4.5 Reagents

- i) Reagent grade chemicals such as American Chemical Society (ACS) shall be used in all tests. Other grade chemicals can also be used provided the reagent is of sufficiently high purity to permit its use without lessening the accuracy of the determination.
- ii) Primary standard buffer salts are available from the National Institute of Standards and Technology (NIST) and should be used in situations where extreme accuracy is required. These solutions should be changed at least once in a month.
- iii) Secondary standard buffers may be obtained from NIST salts or purchased as solvents from commercial vendors. These solutions have been validated by comparison with NIST standards and are recommended for routine use.

#### 7.4.6 Procedure

- i) Calibration: Each instrument/electrode system must be calibrated at a minimum of two points that bracket the expected pH of the samples and are approximately three pH units or more apart.
- ii) For corrosivity characterization, the calibration of the pH meter should include a buffer of pH 2 for acidic wastes and a pH 12 buffer for caustic wastes; also. For corrosivity characterization the sample must be measured at  $25 \pm 1^\circ\text{C}$  if the pH of the waste is above 12.0
- iii) Place the sample or buffer solution in a clean glass beaker using a sufficient volume to cover the sensing elements of the electrodes and to give adequate clearance for the magnetic stirring bar. If field measurements are being made, the electrodes may be immersed directly into the sample stream to an adequate depth and moved in a manner to ensure sufficient sample movement across the electrode-sensing element as indicated by drift-free readings ( $<0.1$  pH).
- iv) Thoroughly rinse and gently wipe the electrodes prior to measuring pH of samples. Immerse the electrodes into the sample beaker or sample stream and gently stir at a constant rate to provide homogeneity and suspension of solids. Note and record sample pH and temperature. Repeat measurement on successive aliquots of sample until values differ by  $<0.1$  pH units. Two or three volume changes are usually sufficient.



## **H10- Liberation of toxic gases in contact with air or water.**

**Test methods are reported for reactive sulfide and reactive cyanide only as applicable to this class of hazardous characteristics.**

### **1. Reactive Sulfide:**

Refer Chapter 9 for sample preparation method.  
Refer Chapter 5; Sec. 5.15 for analytical estimation method.

### **2. Reactive Cyanide:**

Refer Chapter 9 for sample preparation method.  
Refer Chapter 5; Sec. 5.16 for analytical estimation method.

## **7.5 TOXICITY CHARACTERISTIC LEACHING PROCEDURE (TCLP)**

### **7.5.1 Scope and Application**

- i) This method based on USEPA Method 1311-Toxicity Characteristics Leaching Procedure (TCLP), is applicable to the determination of mobility of metals and semi-volatile organic compound in solids.
- ii) If a total analysis of a solid demonstrates that analyte of interest is not detected, or is present in such low concentrations that regulatory leachate limits cannot be exceeded then it is unnecessary to carry out this leaching test.

### **7.5.2 Principle**

The leaching procedure consists of 3 main steps.

#### **a) Crushing/grinding**

The solid sample has to be pass through 9.5-mm sieve. Otherwise, grinding or crushing of the solid is necessary.

#### **b) Determination of appropriate extraction fluid**

Depending on the alkalinity of the solid sample, one of two acetic acid leaching fluids is used to extract the soil.

#### **a) Extraction of solid sample**

- 1) The solid sample is extracted (20:1 liquid to solid ratio) by shaking it end over end for 18 + or – 2 hours at a controlled temperature. The

extract also known as the leachate is then filtered and analysed for the analyte of interest.

- 2) The moisture content of the solid sample is determined separately and reported with the analytical results.

### 7.5.3 Summary of the procedure

From the leachate inorganic and organic species are identified and quantified using appropriate methods as described.

- i) The leaching procedure consists of five main steps.
- ii) For liquid wastes (i.e., those containing 0.5% dry solid material), the waste after filtration through a 0.6 to 0.8 micrometer glass fiber filter, is defined as the TCLP extract.
- iii) For waste containing greater than or equal to 0.5% solids, the liquid, if any, is separated from the solid phase and stored for later analysis.
- iv) Particle size reduction: Prior to extraction, the solid material must pass through a 9.5 mm (0.375-in.) standard sieve have a surface area per gram of material equal to or greater than  $3.1 \text{ cm}^2$ , or, be smaller than 1 cm in its narrowest dimension. If the surface area is smaller or the particle size larger than described above, the solid portion of the waste is prepared for extraction by crushing, cutting, or grinding the waste to the surface area or particle size described above. (Special precautions must be taken if the solids are prepared for organic volatile extraction.)
- v) Extraction of solid material: The solid material from step 2.2 is extracted for 18 + or – 2 hours with an amount of extraction fluid equal to 20 times the weight of the solid phase. The extraction fluid employed is a function of the alkalinity of the solid phase of the waste. A special extractor vessel is used when testing for volatile organics called Zero Head Space Extractor.
- vi) Final separation of the extraction from the remaining solid Following extraction, the liquid extract is separated from the solid phase by filtration through a 0.6 to 0.8 micrometer glass fiber filter. If compatible, the initial liquid phase of the waste is added to the liquid extract, and these are analyzed together. If incompatible, the liquids are analyzed separately and the results are mathematically combined to yield a volume- weighted average concentration.

#### 7.5.4 Interferences

This method describes only the preparation and leaching of the sample to be analyzed. Potential interferences which may be encountered are discussed in the individual analytical methods.

#### 7.5.5 Apparatus

All equipment with which the sample and extract come in contact should be made of inert materials that will not increase or reduce the concentrations of the analytes of interest in the sample. Glass, polytetrafluoroethylene, (PTFE) devices may be used when evaluating both organic and inorganic components. Borosilicate glass bottles are recommended in preference to other glass types, especially when inorganics are being evaluated. Vessels made of high-density polyethylene (HDPE), polypropylene (pp) or poly vinyl chloride (PVC) may be used when evaluating only the mobility of metals.

a) Agitation apparatus:

The agitation apparatus must be capable of rotating the extraction vessels in an end over- end fashion continuously at 30+ or – 2 rpm.

b) Extraction vessels:

Jars or bottles with sufficient capacity to hold the sample and extraction fluid. Two-liter normal capacity bottles are recommended. The vessel type is determined by the analytes of interest.

c) Filtration devices

- b) Filter holders- any filter holder, which meets all of the following requirements. Capable of supporting a 0.6 to 0.8 um glass fibre filter membranes. Has a minimum internal volume of 300 ml (1.5 L recommended) can hold a filter of minimum size 47 mm in diameter (142 mm filter diameter recommended). Positive pressure filtration units capable of exerting pressures of 350 kpa or more (“commonly called Hazardous Waste Filtration Units”

Note: If the leachate is to be analyzed for metals, the filter must be prewashed with 1 M nitric acid, rinsed with DDW and dried before use. Acid washed filters may also be used for other non-volatile extracts.

- c) pH meter: Calibrated to within + or – 0.05 pH units at 25<sup>0</sup>c.

#### 7.5.6 Reagents

All reagents should be of recognized analytical reagent grade.

- a) Nitric acid, 1M
- b) Hydrochloric acid, 1M
- c) Sodium Hydroxide 1 M
- d) Glacial acetic acid
- e) Extraction fluid

Extraction fluid No.1: Add 5.7 ml of glacial acetic acid to 500 ml DDW, add 64.3 ml of 1 M NaOH and dilute to 1 liter. The pH of this fluid should be 4.93 + or – 0.05

Extraction fluid No.2: Dilute 5.7 ml of glacial acetic acid to 1 liter. The pH of this fluid should be 2.88 + or – 0.05.

Note: The extraction fluids should be monitored frequently for impurities and the pH checked before use. Discard if impurities are found or pH is not within specifications.

### **7.5.7 Sample Collection, Preservation and Handling**

The quantity of sample needed must be large enough to support all the requirements of this method. There must be sufficient sample to conduct:

- a) a preliminary evaluation of appropriate extraction fluid;
- b) determination of particle size reduction; and
- c) an extraction of solids for inorganics and or semi-volatile organics.

There should be sufficient sample to provide enough leachate to support each of the necessary analyses, with repeats if necessary and allowing for limits of detection of the analytical methods.

Preservatives must not be added to sample before extraction. Samples should be refrigerated at 4<sup>0</sup>c. The leaching process and analysis of leachate should be carried out as soon as possible. If the extract is to be analyzed for organics, there should be no headspace in the container. Store all extracts at 4<sup>0</sup>c.

### **7.5.8 Procedure**

A minimum of 100 g of sample is required for analysis.

a) **Crushing/grinding:** Examine the sample. The solid has to be able to pass through a 9.5-mm sieve. Otherwise, grind or crush the solid sample to this size.

**b) Determination of appropriate extraction fluid:**

- 1) Transfer 5.0 g (+ or – 0.1 g) of the sample (<9.5 mm) into a 500 ml beaker or Erlenmeyer flask.
- 2) Add 96.5 ml of DDW to the beaker, cover with a watch glass and stir vigorously for 5 minutes using a magnetic stirrer.
- 3) Measure and record the pH. If the pH is  $\leq 5.0$ , use extraction fluid No.1
- 4) If the pH is  $> 5.0$ , add 3.5 ml 1 M HCl, slurry briefly, cover with a watch glass, heat to 50<sup>0</sup>C for 10 minutes. Let the solution cool to room temperature and record the pH. If the pH is  $\leq 5$ , use extraction fluid No.1. Otherwise, use extraction fluid No.2

**c) Extraction of solid waste:**

Enough solid should be used for the extraction (20:1 liquid to solid ratio) such that the volume of leachate will be sufficient to support all of the analyses required. If the volume of leachate from a single extraction is insufficient, several extractions may be performed and the extracts combined for analysis.

A reagent blank with no solid sample should be included with each process batch of samples.

1. Weigh at least 100 g (+ or -0.1 g) of the field sample (<9.5 mm) into an extraction vessel.
2. Add an amount of the appropriate extraction fluid equivalent to 20 times the weight of the sample, to the extraction vessel.
3. Close the extraction vessel tightly (it is recommended that Teflon tape be used to ensure a tight seal), secure in the rotary agitation device and rotate at 30 + or – 2 rpm for 18+ or – 2 hours at ambient temperature (23+ or – 2<sup>0</sup>C).

Note: For some types of solid sample, during the agitation, pressure may build up with in the extraction vessel eg. From evolution of gasses. At periodic intervals (eg. After 15 minutes, 30 minutes and 1 hour) this pressure should be released in fume hood.

4. Assemble the filter holder and filter following manufacturers instructions.
5. Place the 0.6 to 0.8  $\mu\text{m}$  glass fibre filter on the support screen and secure.
6. At the end of the extraction period, transfer the sample to the filter holder and filter the sample.
7. Seal the filtration device and gradually apply vacuum or gentle pressure of 7-70 kPa, and if no additional liquid has passed through the filter in any 2-minute interval, slowly increase the pressure in 70kPa increments to a maximum of 350 kPa. Repeat this until pressurizing gas begins to move through the filter or when liquid flow has ceased at 350kPa. I.e.filtration does not result in any additional filtrate within any 2-minute period.
8. The glass fibre filter may be changed, if necessary, to facilitate filtration. The filtrate collected is called the leachate.

**d) Analysis of leachate**

1. Analyze the leachate as soon as possible. If the analysis cannot be carried out immediately, transfer suitable volumes of the extract into appropriate containers. If the extract is to be analyzed for organics, there should be no headspace in the container. Store all extracts at 4<sup>0</sup>C.
2. Report the analyte concentrations of the leachate in mg/L.
3. Determine the moisture content of the soil separately and report it together with the analytical results.

**7.5.9 Quality Control**

- a) A minimum of one blank must be performed for process batch, using the extraction fluid and extraction vessel type used for the samples.
- b) A matrix spike should be performed for each solid sample type within each batch. Matrix spikes are to be added to the leachate and before preservation. Matrix spikes should not be added prior to extraction of the sample.

## **8.0 MODIFIED TEST FOR SHAKE EXTRACTION OF SOLID WASTE WITH WATER**

### **8.1.0 Materials**

- a) Dilution water double distilled water adjusted to pH 5.5 by acetic acid buffer acid addition immediately to use.
- b) Tailings solids should be representative of the project material.

### **8.1.1 Apparatus**

- a) Agitator may of any type that meets the general requirement at ASTM D3957.
- b) Containers for agitating slurry may be at any size compatible with the agitator apparatus and shall be clean, new, acid washed and rinsed before use.

### **8.1.2 Procedure**

- a) Prior to selecting tailing solids for the procedure they shall be well mixed and free of lumps or standing water. Keep the materials in pails, firmly closed when not in use and store in a cool location.
- b) Immediately after selection take a weighed quantity of well-mixed tailings material and calculate the dry weight of solids and the weight of associated water from the given solids content.
- c) Add sufficient freshly prepared dilution water to give a 4:1 liquid to solid ratio (solids content of 20% by weight). i.e.,  $(\text{dry weight of solids in slurry}) / (\text{water in slurry} + \text{water added}) \times 100 = 20 \text{ percent}$
- d) Sufficient material should be prepared to almost fill the containers to be placed on the agitator.
- e) Place on agitator apparatus and run for 18 hours.

- f) After the completion of the agitation remove the surface water by decantation followed by pressure filtration or centrifugation (good water recovery is essential).
- g) Store all the water recovered without preservation or filtration in a single large clean carboy or else add equal proportions of each new batch or aqueous solution generated to all leach ate storage containers used.
- h) Where preservation is required for analysis representative sub-samples should be taken and suitably treated and labeled.



## CHAPTER 8

# INSTRUMENTS REQUIRED/USED FOR ANALYSIS AND CHARACTERIZATION OF HAZARDOUS WASTE

### 8.0 INSTRUMENTS REQUIRED/USED FOR ANALYSIS AND CHARACTERIZATION OF HAZARDOUS WASTE

In addition to the routine laboratory equipment/instruments, chemicals and glassware required for general environmental laboratory, the list of special/additional equipment and instruments are detailed in this chapter. The instruments required for carrying out analysis and characterization as per the rules can be classified into 3 groups as follows.

- A. Analytical Instruments
- B. Digestion Equipment
- C. Extraction/Distillation

#### A. Analytical Instruments

1. Atomic Absorption Spectrophotometer (AAS): estimation of trace metals in waste samples.
2. Gas Chromatography-Mass spectrometer (GC/MS): Estimation of volatile and semi volatile organic compounds. This is a coupled technique used for estimation of organic compounds in which both chromatograms with retention times, and mass/electron ratio will be obtained for exact identification of organic compounds.
3. Gas chromatography: with different detectors like ECD, FID, NPD, and FPD etc.

*Note: Other Instruments/Equipment are listed in the following table 6.1*

**TABLE 8.1**

**List of Digestion Equipment, Extraction/distillation apparatus, and instruments required for characterization/analysis Of Hazardous Waste.**

S.N.	Instruments required for Analysis and Characterization	Applications
<b>Group-A Digestion Equipment</b>		
1.	Hot plate	Conventional digestion apparatus-All heavy metal digestions can be conducted at 105 <sup>0</sup> c.
2.	Microwave digestion	This is a sophisticated digestion apparatus. Both closed and open type of digestions can be conducted without any loss of analytes under investigation. Digestion can

S.N.	Instruments required for Analysis and Characterization	Applications
		be done at a time for 12 samples and it is very faster than ordinary digestion.
3.	Digesdhal	Useful for digestion of soil contaminated soil, water wastewater samples with in short periods.
4.	Bomb digestion.	
<b>Group-B Extraction/distillation apparatus</b>		
5.	Soxhlet extraction apparatus.	
6.	Cyanide distillation apparatus	Designed exclusively for reactive cyanide distillation.
7.	Sulfide distillation apparatus.	Designed exclusively for reactive sulfide distillation.
8.	K.D apparatus with Snyder columns	Designed for Pre concentration of the sample with only Solvent evaporation through spiral Snyder column leaving the sample under investigation. Conversion of sample into gaseous phases and back condensation into liquid state takes place.
9.	Fractional distillation apparatus	Distillation of solvents.
10.	Rotavapor.	For solvent recovery.
11.	TCLP Agitator	Shaking or extraction apparatus for leachate generation- Useful for estimation of semi volatile organics and heavy metals from the leachate.
12.	ZHE (Zero Head Space Extractor).	Designed for extraction of leachate without any head space- useful for estimation of volatile organic compounds from leachate.
<b>Group-C Analytical instruments</b>		
13.	pH meter	Elcrometric measurement of ph.
14.	Karl-fisher moisture content meter.	Estimation of moisture content up to 100% in field waste samples.
15.	Conductometer	Measurement of electrical conductivity.
16.	Flash point apparatus	To find flash point of liquid or solvent wastes.
17.	Bomb calorimeter	To find calorific value of the waste.
18.	Uv-Visible spectrophotometer (Preferably Double-beam)	Colorimetric estimation of metals, anoins, phenols etc.,
19.	Atomic Absorption Spectrophotometer. (AAS)	Useful for estimation of trace metal/element analysis. Using this instrument more than 65 elements of the periodic table can be estimated.
20.	AAS/Hydride Vapour Generation system (AAS/GH)	It is an accessory to AAS, and is required to estimate metals like Arsenic, Selenium and Mercury through cold vapor generation.
21.	Elemental Analyser	Useful for estimation of total Organic Carbon, Hydrogen, Nitrogen, Sulphur, and total Oxygen.
22.	Gas Chromatography (GC)	Useful for estimation of semi volatile, and volatile organic constituents present in the waste by specific detectors like FID, FPD, ECD, etc.,

S.N.	Instruments required for Analysis and Characterization	Applications
23.	Gas Chromatography/ Mass Spectrograph. (GC/MS)	It is a coupled technique, of both Gas chromatography with Mass Spectrometer. Initially sample passes through column and gets resolved, then it gets disintegrated into fragment ions with characteristic M/E ratio. Therefore the resolved sample can be compared in mass spectrum for further compound confirmation.
24.	Ion Selective Electrodes	It is specific ion meter useful for the quantification of total Sulfide, total cyanide, chloride, nitrate, nitrite and flouride ions. Samples with different type of matrixes can be estimated using this instrument with minimal interferences.
25.	Total Organic Carbon Analyser	Useful for estimation of total organic carbon.

## CHAPTER 9

# ADDITIONAL ANALYTICAL METHODS

### 9.1 TOTAL ORGANIC CARBON

#### 9.1.1 Scope and Application

- a) This method is used to determine the concentration of organic carbon in ground water, surface and saline waters, and domestic and industrial wastes.
- b) This method is most applicable to measurement of organic carbon above 1 mg/L.

#### 9.1.2 Summary of Method

- a) Organic carbon is measured using a carbonaceous analyzer. This instrument converts the organic carbon in a sample to carbon dioxide (CO<sub>2</sub>) by either catalytic combustion or wet chemical oxidation. The CO<sub>2</sub> formed is then either measured directly by an infrared detector or converted to methane (CH<sub>4</sub>) and measured by a flame ionization detector. The amount of CO<sub>2</sub> or CH<sub>4</sub> in a sample is directly proportional to the concentration of carbonaceous material in the sample.
- b) Carbonaceous analyzers are capable of measuring all forms of carbon in a sample. However, because of various properties of carbon-containing compounds in liquid samples, the manner of preliminary sample treatment as well as the instrument settings will determine which forms of carbon are actually measured. The forms of carbon that can be measured by this method:
  - 1. Soluble, nonvolatile organic carbon: e.g., natural sugars.
  - 2. Soluble, volatile organic carbon: e.g., mercaptans, alkanes, low molecular weight alcohols.
  - 3. Insoluble, partially volatile carbon: e.g., low molecular weight oils.
  - 4. Insoluble, particulate carbonaceous materials: e.g., cellulose fibers.
  - 5. Soluble or insoluble carbonaceous materials adsorbed or entrapped on insoluble inorganic suspended matter: e.g., oily matter adsorbed on silt particles.
- c) Carbonate and bicarbonate are inorganic forms of carbon and must be separated from the total organic carbon value. Depending on the instrument manufacturer's instructions, this separation can be accomplished by either a simple mathematical subtraction, or by removing the carbonate and bicarbonate by converting them to CO<sub>2</sub> with degassing prior to analysis.

### 9.1.3 Interferences

- a) Carbonate and bicarbonate carbon represent an interference under the terms of this test and must be removed or accounted for in the final calculation.
- b) This procedure is applicable only to homogeneous samples, which can be injected into the apparatus reproducibly by means of a micro liter-type syringe or pipet. The openings of the syringe or pipet limit the maximum size of particle which may be included in the sample.
- c) Removal of carbonate and bicarbonate by acidification and purging with nitrogen, or other inert gas, can result in the loss of volatile organic substances.

### 9.1.4 Apparatus and Materials

- a) Apparatus for blending or homogenizing samples: Generally, a Waring-type blender is satisfactory.
- b) Apparatus for total and dissolved organic carbon: No specific analyzer is recommended as superior. If the technique of chemical oxidation is used, the laboratory must be certain that the instrument is capable of achieving good carbon recoveries in samples containing particulates.

### 9.1.6 Reagents

- a) DDW
- b) Potassium hydrogen phthalate, stock solution, and 1,000-mg/L carbon: Dissolve 0.2128 g of potassium hydrogen phthalate (primary standard grade) in DDW and dilute to 100.0 mL.  
*NOTE: Sodium oxalate and acetic acid are not recommended as stock solutions.*
- c) Potassium hydrogen phthalate, standard solutions: Prepare standard solutions from the stock solution by dilution with DDW.
- d) Carbonate-bicarbonate, stock solution, 1,000 mg/L carbon: Weigh 0.3500 g of sodium bicarbonate and 0.4418 g of sodium carbonate and transfer both to the same 100-mL volumetric flask. Dissolve with DDW
- e) Carbonate-bicarbonate, standard solution: Prepare a series of standards  
*NOTE: This standard is not required by some instruments.*
- f) Blank solution: Use the same DDW as was used to prepare the standard solutions.

### 9.1.6 Procedure

- a) Homogenize the sample in a blender.

NOTE: To avoid erroneously high results, inorganic carbon must be accounted for. The preferred method is to measure total carbon and inorganic carbon and to obtain the organic carbon by subtraction

- b) Lower the pH of the sample to 2.
- c) Purge the sample with nitrogen for 10 min. Follow instrument manufacturer's instructions for calibration, procedure, and calculations.
- d) For calibration of the instrument, a series of standards should be used that encompasses the expected concentration range of the samples
- e) Quadruplicate analysis is required. Report both the average and the range.

### 9.1.7 Quality Control

- a) All quality control data should be maintained and available for easy reference or inspection.
- b) Employ a minimum of one blank per sample batch to determine if contamination or any memory effects are occurring.
- c) Verify calibration with an independently prepared check standard for every 15 samples.
- d) Run one spike duplicate sample for every 10 samples. A duplicate sample is a sample brought through the whole sample preparation and analytical process.

---

Ref: Method 9060 Total Organic Carbon USEPA SW846

## 9.2 TEST METHOD TO DETERMINE HYDROGEN CYANIDE RELEASED FROM WASTES

### 9.2.1 Scope and Application

- a) This method is applicable to all wastes, with the condition that wastes that are combined with acids do not form explosive mixtures.
- b) This method provides a way to determine the specific rate of release of hydrocyanic acid upon contact with an aqueous acid.

- c) This test measures only the hydrocyanic acid evolved at the test conditions. It is not intended to measure forms of cyanide other than those that are evolvable under the test conditions.

### 9.2.2 Summary of Method

- a) An aliquot of acid is added to a fixed weight of waste in a closed system. The generated gas is swept into a scrubber. The analyte is quantitated. The procedure for quantitating the cyanide is given in chapter-3.

### 9.2.3 Interferences

Interferences are undetermined.

### 9.2.4 Apparatus and Materials (fig 9.1)

- a) Round-bottom flask - 500-mL, three-neck, with 24/40 ground-glass joints.
- b) Gas scrubber - 50 mL calibrated scrubber
- c) Stirring apparatus - To achieve approximately 30 rpm. This may be either a rotating magnet and stirring bar combination or an overhead motor-driven propeller stirrer.
- d) Addition funnel - With pressure-equalizing tube and 24/40 ground-glass joint and Teflon sleeve.
- e) Flexible tubing - For connection from nitrogen supply to apparatus.
- f) Water-pumped or oil-pumped nitrogen gas - With two-stage regulator.
- g) Rotometer - For monitoring nitrogen gas flow rate.
- h) Analytical balance - capable of weighing to 0.001 g.

### 9.2.5 Reagents

- a) Reagent grade inorganic chemicals shall be used in all tests.
- b) DDW.
- c) Sulfuric acid (0.01N), H<sub>2</sub>SO<sub>4</sub>. Add 2.8 mL concentrated H<sub>2</sub>SO<sub>4</sub> to DDW 1 L. Withdraw 100 mL of this solution and dilute to 1 L to make the 0.01N H<sub>2</sub> SO<sub>4</sub>.

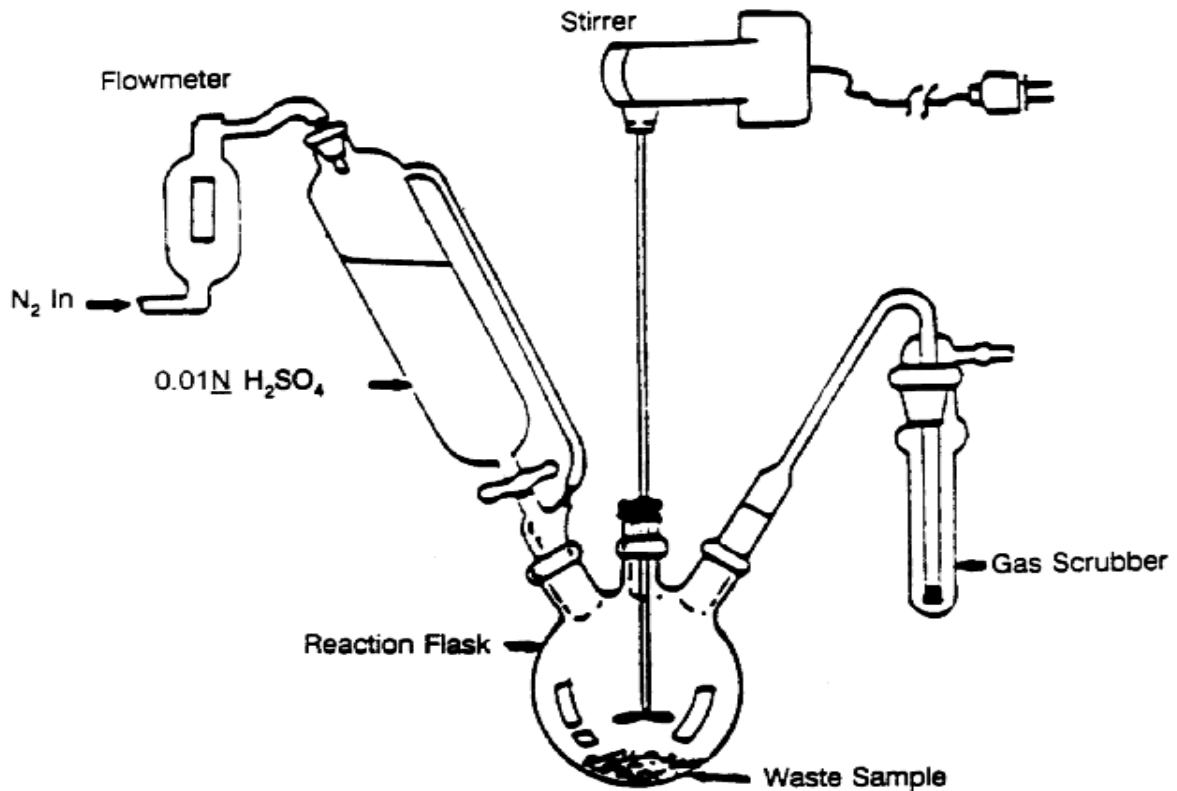

**Fig. 9.1 Apparatus Determine Hydrogen Sulfide Released from Waste**

- d) Cyanide reference solution, (1000 mg/L). Dissolve approximately 2.5 g of KOH
- e) and 2.51 g of KCN in 1 liter of DDW. Standardize with 0.0192N  $\text{AgNO}_3$ . Cyanide concentration in this solution should be 1 mg/mL.
- f) Sodium hydroxide solution (1.25N), NaOH. Dissolve 50 g of NaOH in reagent water and dilute to 1 liter DDW.
- g) Sodium hydroxide solution (0.25N), NaOH. Dilute 200 mL of 1.25N sodium hydroxide solution to 1 liter DDW.
- h) Silver nitrate solution (0.0192N). Prepare by crushing approximately 5 g of  $\text{AgNO}_3$  crystals and drying to constant weight at  $40^\circ\text{C}$ . Weigh 3.265 g of dried  $\text{AgNO}_3$ , dissolve in DDW, and dilute to 1 liter.

### 9.2.6 Procedure

- a) Add 50 mL of 0.25N NaOH solution to a calibrated scrubber and dilute with DDW to obtain an adequate depth of liquid.



- b) Close the system and adjust the flow rate of nitrogen, using the rotometer. Flow should be 60 mL/min.
- c) Add 10 g of the waste to be tested to the system.
- d) With the nitrogen flowing, add enough sulfuric acid to fill the flask half full. Start the 30-minute test period.
- e) Begin stirring while the acid is entering the round-bottom flask. The stirring speed must remain constant throughout the test.  
*NOTE: The stirring should not be fast enough to create a vortex.*
- f) After 30 minutes, close off the nitrogen and disconnect the scrubber. Determine the amount of cyanide in the scrubber by method described in 5<sup>th</sup> chapter.

### 9.2.7 Calculations

- a) Determine the specific rate of release of HCN, using the following parameters:

$X$  = Concentration of HCN in diluted scrubber solution (mg/L)

$L$  = Volume of solution in scrubber (L)

$W$  = Weight of waste used (kg)

$S$  = Time of measurement (sec.) = Time N stopped - Time N started  $X \cdot L$

$R$  = specific rate of release (mg/kg/sec.) =  $W \cdot S$

Total releasable HCN (mg/kg) =  $R \times S$

Ref: Method Chapter-7 of USEPA SW846

## 9.3 TEST METHOD TO DETERMINE HYDROGEN SULFIDE RELEASED FROM WASTES

### 9.3.1 Scope and Application

- a) This method is applicable to all wastes, with the condition that waste that are combined with acids do not form explosive mixtures.
- b) This method provides a way to determine the specific rate of release of hydrogen sulfide upon contact with an aqueous acid.

- c) This procedure releases only the hydrogen sulfide evolved at the test conditions. It is not intended to measure forms of sulfide other than those that are evolvable under the test conditions.

### 9.3.2 Summary of Method

An aliquot of acid is added to a fixed weight of waste in a closed system. The generated gas is swept into a scrubber. The analyte is quantified. The procedure for quantifying the sulfide is given in chapter-5.

### 9.3.3 Interferences

Interferences are undetermined.

### 9.3.4 Apparatus and Materials (Fig 9.2)

- a) Round-bottom flask - 500-mL, three-neck, with 24/40 ground-glass joints.
- b) Gas scrubber - 50 mL calibrated scrubber.
- c) Stirring apparatus - To achieve approximately 30 rpm. This may be either a rotating magnet and stirring bar combination or an overhead motor-driven propeller stirrer.
- d) Addition funnel - With pressure-equalizing tube and 24/40 ground-glass joint and Teflon sleeve.
- e) Flexible tubing - For connection from nitrogen supply to apparatus.
- f) Water-pumped or oil-pumped nitrogen gas - With two-stage regulator.
- g) Rotometer - For monitoring nitrogen gas flow rate.
- h) Analytical balance - capable of weighing to 0.001 g.

### 9.3.5 Reagents

- a) Reagent grade inorganic chemicals shall be used in all tests.
- b) DDW.  
  
Sulfuric acid (0.01N),  $H_2SO_4$ . Add 2.8 mL concentrated  $H_2SO_4$  to DD water and dilute to 1 L. Withdraw 100 mL of this solution and dilute to 1 L to make the 0.01N  $H_2SO_4$
- c) Sulfide reference solution - Dissolve 4.02 g of  $Na_2S \cdot 9H_2O$  in 1.0 L of DD water. This solution contains 570-mg/L hydrogen sulfide. Dilute this stock solution to cover the analytical range required (100-570 mg/L).

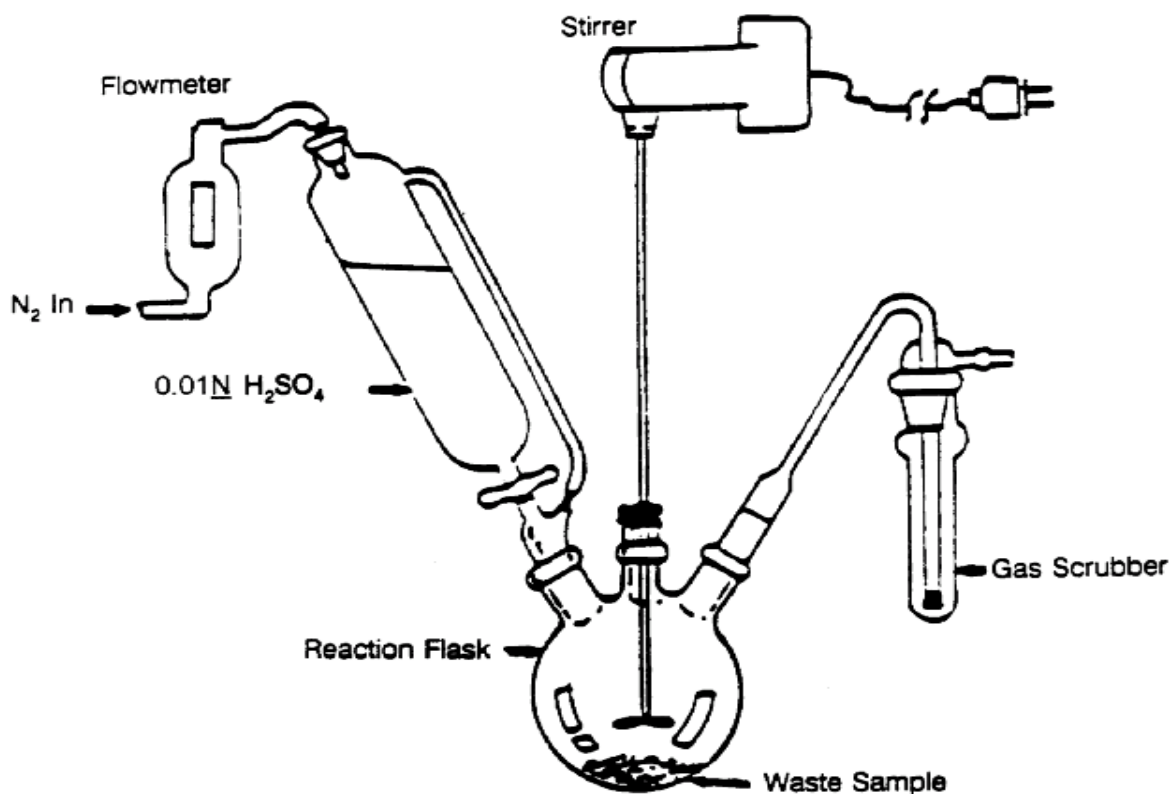

**Fig. 9.2 Apparatus to Determine Hydrogen Cyanide Released from Waste**

- d) Sodium hydroxide solution (1.25N), NaOH. Dissolve 50 g of NaOH in DD water and dilute to 1 L with organic-free reagent water.
- e) Sodium hydroxide solution (0.25N), NaOH. Dilute 200 mL of 1.25N sodium hydroxide solution (Step 5.5) to 1 L with DDW.

### 9.3.6 Procedure

- a) Add 50 mL of 0.25N NaOH solution to a calibrated scrubber and dilute with DDW to obtain an adequate depth of liquid..
- b) Assemble the system and adjust the flow rate of nitrogen, using the rotometer. Flow should be 60 mL/min.
- c) Add 10 g of the waste to be tested to the system.
- d) With the nitrogen flowing, add enough sulfuric acid to fill the flask half full, while starting the 30-minute test period.
- e) Begin stirring while the acid is entering the round-bottom flask. The stirring speed must remain constant throughout the test.

*NOTE: The stirring should not be fast enough to create a vortex.*

- f) After 30 minutes, close off the nitrogen and disconnect the scrubber. Determine the amount of sulfide in the scrubber by Method given in chapter-5
- g) The trapping solution must be brought to a pH of 2 before proceeding. Titrate a small aliquot of the trapping solution to a pH 2 end point with 6N HCl and calculate the amount of HCl needed to acidify the entire scrubber solution. Combine the small-acidified aliquot with the remainder of the acidified scrubber solution.

### 9.3.7 Calculations

Determine the specific rate of release of H<sub>2</sub>S, using the following parameters:

- X = Concentration of H<sub>2</sub>S in scrubber (mg/L). (This is obtained from Method 9034.)
  - L = Volume of solution in scrubber (L)
  - W = Weight of waste used (kg)
  - S = Time of experiment (sec.) = Time N stopped - Time N started
  - R = specific rate of release (mg/kg/sec.) =  $\frac{W \cdot X}{S}$
  - Total releasable H<sub>2</sub>S (mg/kg) = R x W
- E 3 (continued)

Ref: Method Chapter-7 of USEPA SW846

## 9.4 PAINT FILTER LIQUIDS TEST

### 9.4.1 Scope and Application

This method is used to determine the presence of free liquids in a representative sample of waste.

### 9.4.2 Summary of Method

A predetermined amount of material is placed in a paint filter. If any portion of the material passes through and drops from the filter within the 5-min test period, the material is deemed to contain free liquids.

### 9.4.3 Interferences

- a) Filter media were observed to separate from the filter cone on exposure to alkaline materials. This development causes no problem if the sample is not disturbed.
- b) Temperature can affect the test results if the test is performed below the freezing point of any liquid in the sample. Tests must be performed above the freezing point and can, but are not required to, exceed room temperature of 25°C

#### 9.4.4 Apparatus and Materials

- a) Conical paint filter: Mesh number 60 +/- 5% (fine meshed size).
- b) Glass funnel: If the paint filter, with the waste, cannot sustain its weight on the ring stand, then a fluted glass funnel or glass funnel with a mouth large enough to allow at least 1 in. of the filter mesh to protrude should be used to support the filter. The funnel should be fluted or have a large open mouth in order to support the paint filter yet not interfere with the movement, to the graduated cylinder, of the liquid that passes through the filter mesh.
- c) Ring stand and ring, or tripod.
- d) Graduated cylinder or beaker: 100-mL.

#### 9.4.6 Procedure

- a) Assemble test apparatus as shown in (Fig 9.3).

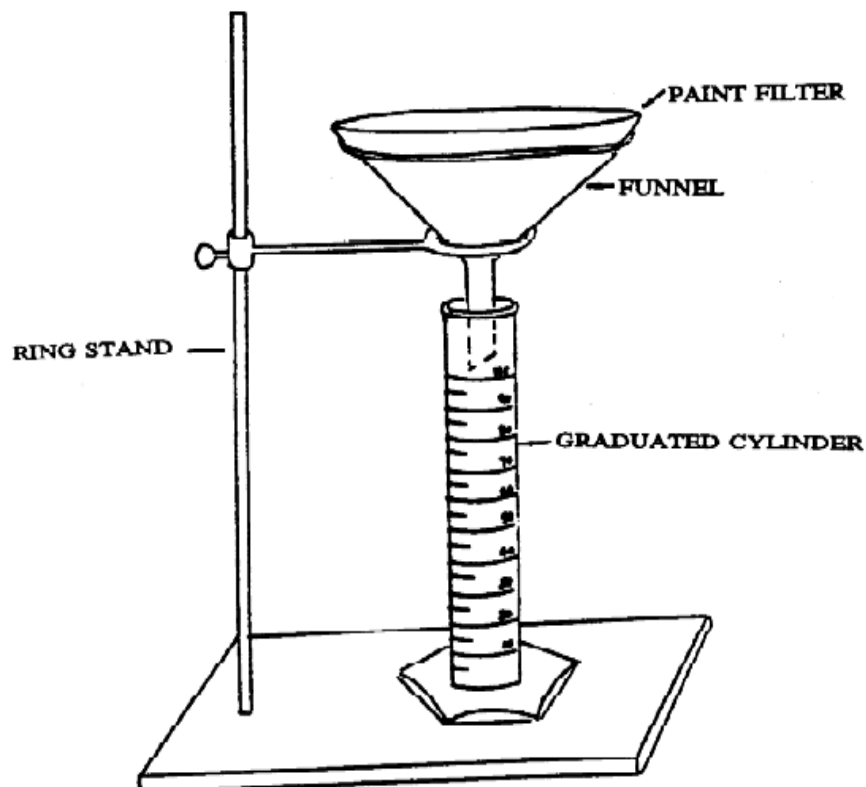

**Fig. 9.3 Paint Filter Test Apparatus**

- b) Place sample in the filter. A funnel may be used to provide support for the paint filter. If the sample is of such light bulk density that it overflow the filter, then the sides of the filter can be extended upward by taping filter paper to the inside of the filter and above the mesh. Settling the sample into the paint filter may be facilitated by lightly tapping the side of the filter as it is being filled.
- c) In order to assure uniformity and standardization of the test, material such as sorbent pads or pillows which do not conform to the shape of the paint filter, should be cut into small pieces and poured into the filter. Sample size reduction may be accomplished by cutting the sorbent material with scissors, shears, knife, or other such device so as to preserve as much of the original integrity of the sorbent fabric as possible. Sorbents enclosed in a fabric should be mixed with the resultant fabric pieces. The particles to be tested should be reduced smaller than 1 cm (i.e., should be capable of passing through a 9.5 mm (0.375 inch) standard sieve). Grinding sorbent materials should be avoided as this may destroy the integrity of the sorbent and produce many "fine particles" which would normally not be present.
- d) For brittle materials larger than 1 cm that do not conform to the filter, light crushing to reduce oversize particles is acceptable if it is not practical to cut the material. Materials such as clay, silica gel, and some polymers may fall into this category.
- e) Allow sample to drain for 5 min into the graduated cylinder.
- f) If any portion of the test material collects in the graduated cylinder in the 5-min period, then the material is deemed to contain free liquids

#### **9.4.7 Quality Control**

Duplicate samples should be analyzed on a routine basis.

---

Ref: Method 9095A Paint Filter Liquid Test of USEPA SW846

### **9.5 LIQUID RELEASE TEST PROCEDURE**

#### **9.5.1 Scope and Application**

- a) The Liquid Release Test (LRT) is a laboratory test designed to determine whether or not liquids will be released from sorbents when they are subjected to overburden pressures in a landfill.
- b) Any liquid-loaded sorbent that fails the EPA Paint Filter Free Liquids Test (PFT) may be assumed to release liquids in this test. Analysts should ensure that the material in question will pass the PFT before performing the LRT.

### 9.5.2 Summary of Method

A representative sample of the liquid-loaded sorbent, standing 10 cm high in the device, is placed between twin stainless steel screens and two stainless-steel grids, in a device capable of simulating landfill overburden pressures. An absorptive filter paper is placed on the side of each stainless-steel grid opposite the sample. A compressive force of 50 psi is applied to the top of the sample. Release of liquid is indicated when a visible wet spot is observed on either filter paper.

### 9.5.3 Interferences

- a) When testing sorbents are loaded with volatile liquids (e.g., solvents), any released liquid migrating to the filter paper may rapidly evaporate. For this reason, filter papers should be examined immediately after the test has been conducted.
- b) It is necessary to thoroughly clean and dry the stainless-steel screens prior to testing to prevent false positive or false negative results. Material caught in screen holes may impede liquid transmission through the screen causing false negative results. A stiff bristled brush, like those used to clean testing sieves, may be used to dislodge material from holes in the screens. The screens should be ultrasonically cleaned with a laboratory detergent, rinsed with deionized water, rinsed with acetone, and thoroughly dried. When sorbents containing oily substances are tested, it may be necessary to use solvents (e.g., methanol or methylene chloride) to remove any oily residue from the screens and from the sample holder surfaces.
- c) When placing the 76 mm screen on top of the loaded sample it is important to ensure that no sorbent is present on top of the screen to contact the filter paper and cause false positive results. In addition, some sorbent residue may adhere to container sidewalls and contact the filter as the sample compresses under load, causing wet spots on the edges of the filter. This type of false positive may be avoided by carefully centering the 76 mm filter paper in the device prior to initiating the test.
- d) Visual examination of the sample may indicate that a release is certain (e.g., free standing liquid or a sample that flows like a liquid), raising concern over unnecessary clean up of the LRT device. An optional 5 minute Pre-Test, described in Appendix A of this procedure, may be used to determine whether or not an LRT must be performed.

### 9.5.4 Apparatus and Materials

- a) LRT Device (LRTD): A device capable of applying 50 psi of pressure continuously to the top of a confined, cylindrical sample (**see Figure**

**9.4).** The pressure is applied by a piston on the top of the sample. All device components contacting the sample (i.e., sample-holder, screens, and piston) should be resistant to attack by substances being tested. The LRTD consists of two basic components, described below.

- b)** Sample holder: A rigid-wall cylinder, with a bottom plate, capable of holding a 10 cm high by 76 mm diameter sample.
- c)** Pressure Application Device: In the LRTD (**Figure 5**), pressure is applied to the sample by a pressure rod pushing against a piston that lies directly over the sample. The rod may be pushed against the piston at a set pressure using pneumatic, mechanical, or hydraulic pressure. Pneumatic pressure application devices should be equipped with a pressure gauge accurate to within + 1 psi, to indicate when the desired pressure has been attained and whether or not it is adequately maintained during the test. Other types of pressure application devices (e.g., mechanical or hydraulic) may be used if they can apply the specified pressure continuously over the ten-minute testing time. The pressure application device must be calibrated by the manufacturer, using a load cell or similar device placed under the piston, to ensure that 50 + 1 psi is applied to the top of the sample. The pressure application device should be sufficiently rugged to deliver consistent pressure to the sample with repeated use.
- d)** Stainless-Steel Screens: To separate the sample from the filter, thereby preventing false positive results from particles falling on the filter paper. The screens are made of stainless steel and have hole diameters of 0.012 inches with 2025 holes per square inch. Two diameters of screens are used: a larger (90 mm) screen beneath the sample and a smaller (76 mm) screen that is placed on top of the sample in the sample-holding cylinder.
- e)** Stainless-Steel Grids: To provide an air gap between the stainless-steel screen and filter paper, preventing false positive results from capillary action. The grids are made of 1/32" diameter, woven, stainless steel wire cut to two diameters, 90 mm and 76 mm.
- f)** Filter Papers: To detect released liquid. Two sizes, one 90 mm and one 76 mm, are placed on the side of the screen opposite the sample. The 76 mm diameter filter paper has the outer 6 mm cut away except 3 conical points used for centering the paper (see Figure 2). Blue, seed-germination filter paper manufactured by Schleicher and Schuell (Catalog Number 33900) is suitable. Other colored, absorptive papers may be used as long as they provide sufficient wet/dry contrast for the operator to clearly see a wet spot.
- g)** Spatula: To assist in loading and removing the sample.



FIGURE 9.4  
LRT DEVICE

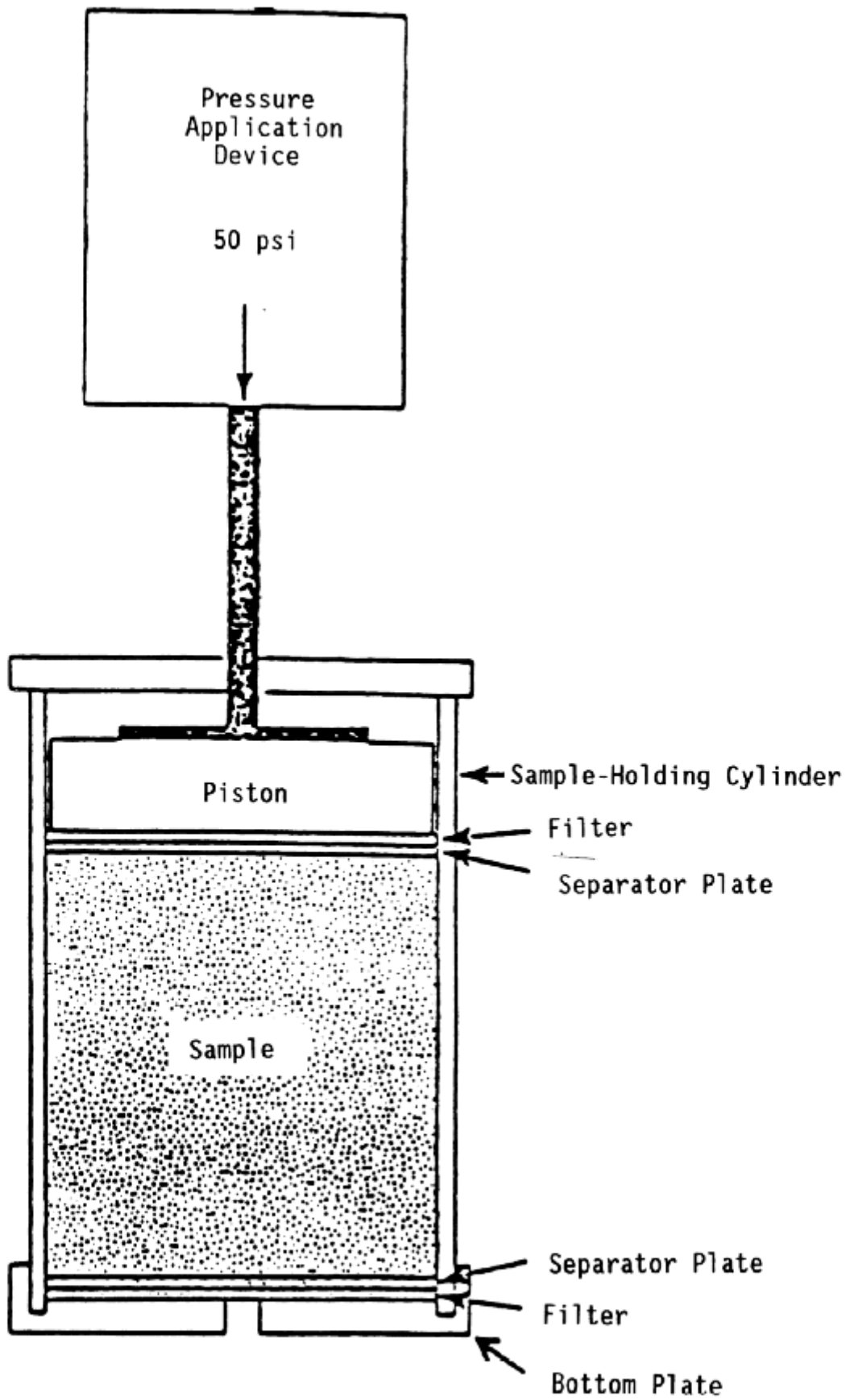

- h) Rubber or wooden mallet: To tap the sides of the device to settle and level the sample.

#### **9.4.5 Reagents**

- a) Reagent grade chemicals shall be used in all tests. Unless otherwise indicated, it is intended that all reagents shall conform to the specifications of the Committee on Analytical Reagents of the American Chemical Society, where such specifications are available. Other grades may be used, provided it is first ascertained that the reagent is of sufficiently high purity to permit its use without lessening the accuracy of the determination.
- b) DDW
- c) Acetone

#### **Sample Collection, Preservation and Handling**

All samples should be collected using a sampling plan that addresses the considerations discussed in chapter-2 of the manual. The sampling plan should be designed to detect and sample any pockets of liquids that may be present in a container (i.e., in the bottom or top of the container).

- a) Preservatives should not be added to samples.
- b) Samples should be tested as soon as possible after collection, but in no case after more than three days after collection. If samples must be stored, they can be stored in sealed containers and maintained under dark, cool conditions (temperature ranging between 35<sup>0</sup>C and 72<sup>0</sup>C). Samples should not be frozen.

#### **9.4.6 Procedure**

- a) The procedure below was developed for the original LRTD, manufactured by Associated Design and Manufacturing Company (ADM). Procedures for other LRTDs, along with evidence for equivalency to the ADM device, should be supplied by the manufacturer.
- b) Disassemble the LRTD and make sure that all parts are clean and dry.
- c) Invert the sample-holding cylinder and place the large stainless-steel screen, the large stainless-steel grid, then and a 90 mm filter paper on the cylinder base (bottom-plate side).
- d) Secure the bottom plate (plate with a hole in the center and four holes located on the outer circumference) to the flange on the bottom of the sample-holding cylinder using four knob screws.

- e) Turn the sample holder assembly to the right-side-up position (bottom-plate-side down). Fill the sample holder with a representative sample until the sample height measures 10 cm (up to the etched line in the cylinder).
- f) Tap the sides of the sample holder with a rubber or wooden mallet to remove air pockets and to settle and level the sample.
- g) Repeat filling, and tapping until a sample height of 10 cm is maintained after tapping.
- h) Smooth the top of the sample with a spatula to create a horizontal surface.
- i) Place the small stainless-steel screen, then the small stainless-steel grid on top of the sample.

*NOTE: Prior to placing the stainless-steel grid on top of the screen; make sure that no sorbent material is on the grid side of the stainless-steel screen.*

- j) Place the 76 mm filter paper on top of the small stainless-steel grid; making sure the filter paper is centered in the device.
- k) Using the piston handle (screwed into the top of the piston) lower the piston into the sample holder until it sits on top of the filter paper. Unscrew and remove the handle.
- l) Place the loaded sample holder into position on the base plate and lock into place with two toggle clamps.
- m) Place the pressure application device on top of the sample-holder. Rotate the device to lock it into place and insert the safety key.
- n) Connect airlines.
- o) initiate rod movement and pressure application by pulling the air-valve lever toward the operator and note time on data sheet. The pressure gauge at the top of the pressure application device should read as specified in the. September 1994 factory calibration record for the particular device. If not, adjust regulator to attain the specified pressure.

*NOTE: After pressure application, the air lines can be disconnected, the toggle clamps can be released, and the LRTD can be set aside for 10 minutes while other LRTDs are pressurized. LRTD pressures should be checked every 3 minutes to ensure that the specified pressure is being maintained. If the specified pressure is not being maintained to within + 5 psi, the LRTD must be reconnected to the airlines and pressure applied throughout the 10 minute test.*

- p) After 10 minutes place the LRTD on the base plate, reconnect airlines and toggle clamps, and turn off pressure (retract the rod) by pushing the air-valve lever away from the operator. Note time on data sheet.
- q) When the air gauge reaches 0 psi, disconnect the airlines and remove the pressure-application device by removing the safety key, rotating the device, and lifting it away from the sample holder.
- r) Screw the piston handle into the top of the piston.
- s) Lift out the piston.
- t) Remove the filter paper and immediately examine it for wet spots (wet area on the filter paper). The presence of a wet spot(s) indicates a positive test (i.e., liquid release). Note results on data sheet.
- u) Release toggle clamps and remove sample holder from base plate. Invert sample holder onto suitable surface and remove the knob screws holding the bottom plate.
- v) Remove the bottom plate and immediately examine the filter paper for wet spots. Note results on data sheet. Wet spot(s) on either filter indicates a positive test.

#### **9.4.8 Quality Control**

Duplicate samples should be analyzed every twenty samples or every analytical batch, whichever is more frequent. Refer to Chapter One for additional QC protocols.

#### **9.4.9 Procedure**

- a) Paint one strip, approximately 1 cm wide, of methylene blue dye across the center of a clean and dry glass plate . The dye is allowed to dry.
- b) Paint one strip, approximately 1 cm wide, of anthraquinone dye across the center of the same glass plate. This strip should be adjacent to and parallel with the methylene blue strip. The dye is allowed to dry.
- c) Place the glass grid in the center of the dye-painted glass plate. Place a small amount of sample into the glass-grid holes, pressing down gently until the holes are filled to slightly above the grid top.
- d) Place a second, clean and dry, glass plate on top of the sample and grid.
- e) Place a 2.7 kg weight on top of the glass for 5 minutes.

- f) After 5 minutes remove the weight and examine the base of the grid extending beyond the sample holes for any indication of dyed liquid. The entire assembly may be turned upside down for observation. Any indication of liquid constitutes a release and the LRT does not need to be performed.

---

**Ref: Method 9096 Liquid Release Test procedure of USEPA SW846**